

Table of Contents



NEW PRODUCT BLACK MIRROR FINISH FENDERS	
Black Mirror Finish Half Fenders	2
Black Mirror Finish Tandem Fenders	3
Black Mirror Finish Single Axle Fenders	4
BLACK MIRROR FINISH MOUNTING KITS	
Black Mirror Finish Half Fender Mounting Kits	5
Black Mirror Finish Tandem Fender Mounting Kits	6
Black Mirror Finish Single Axle Fender Mounting Kits	7
NEW PRODUCT ALUMINUM FENDERS	
.125 Thick Wall Aluminum Fenders	8
.090 Smooth Aluminum Half Fenders	9
.090 Smooth Aluminum Tandem and Single Axle Fenders	10
NEW PRODUCT DIAMOND PLATE CONSTRUCTION FENDER	11
304 PERFECT MIRROR FINISH FENDERS AND MOUNTING KITS	
Mirror Finish Quarter Fenders	12
Mirror Finish Half Fenders	13
Mirror Finish Tandem Fenders	14
Mirror Finish Single Axle	15
Mirror Finish Mounting Kits	16 - 18
HIDDEN BRACKET KITS	
Half Fender Hidden Bracket Kits	19
Tandem Fender Hidden Bracket Kits	20
Single Axle Hidden Bracket Kits	21
Single Axle Hidden Bracket Kits	22
QUARTER FENDERS	23 - 24
HALF FENDERS	
Smooth	25
Long Front	26
3 Rib	27 - 30
4 Rib	31
TANDEM FENDERS	
Smooth	32
3 Rib	33
4 Rib	34
SINGLE AXLE	
Smooth	35
3 Rib	36-37
4 Rib	38-39
POLY FENDERS & POLY MOUNTING KITS	
Single Axle & Super Single	40-41
Half & Tandem	42 - 43
Poly Single Axle Trailer Fender	44
Poly 1/2 Fender Mounting Kits	45 - 46
Poly Tandem Fender Mounting Kits	47 - 48
Poly Single Axle, Half & Tandem Mounting Kits	49 - 56
TANKER FENDERS	57 - 60
FENDER MOUNTING ACCESSORIES	61 - 64
FENDER MOUNTING KITS	
Half Fender Mounting Kits	65-72
Tandem Fender Mounting Kits	73-82
Single Axle Mounting Kits	83 -87
Rear Centre Panels	88
Anti Sail Brackets & Mud Flap Weights	89
Flexible Mud Flap Hangers	90
Bulk & Barrel Sets	91
Spring Loaded Mud Flap Hangers	92
Flat Top Mud Flap Hanger Light Bars	93-94
HD Triangle Mount & 360 Post Mount	95
Retail Ready Packaging	96
Fender Specifications	97
Cross Reference	98 - 103
Terms and Policies	104



New Product - Black Mirror Finish Half Fenders

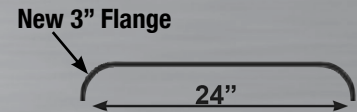

72" Black Mirror Finish Half Fenders

FS72S14BMF 72" Black Mirror Finish Half Fender
(35" - 37") 14 GA 83 lbs per set
Fits 43" or 46.5" Tires



FS72S14LFBMF 72" Black Mirror Finish Long Front Half Fender
(41" - 31") 14 GA 83 lbs per set
Fits 43" or 46.5" Tires

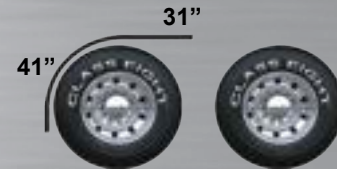

80" Black Mirror Finish Half Fenders

FS80S14BMF 80" Black Mirror Finish Half Fender
(49" - 31") 14 GA, 92 lbs per set
Fits 43" or 46.5" Tires

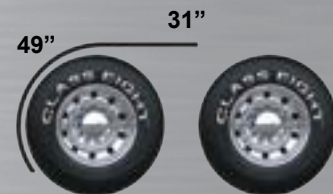

FS80S14LFBMF 80" Black Mirror Finish Long Front Half Fender
(41" - 39") 14 GA, 92 lbs per set
Fits 43" or 46.5" Tires

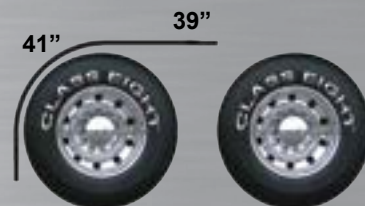

FS80S14ELFBMF 80" Black Mirror Finish Half Fender Extra Long Front
(49" - 31") 14 GA, 92 lbs per set
Fits 43" or 46.5" Tires



Black Mirror Finish Tandem Fenders



New 3" Flange

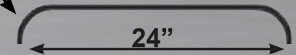

144" Black Mirror Finish Tandem, 54" Spread

FS14454S14BMF

144" Black Mirror Finish Tandem Fender
Rolled Edge (Curled Under)
(45" - 54" - 45") 14 GA, 166 lbs per set
Fits 43" Tire



FS14454S14ELFBMF

144" Black Mirror Finish Extra Long Front & Back Tandem
Fender, Rolled Edge (Straight Down)
(45" - 54" - 45") 14 GA, 166 lbs per set
Fits 43" Tire

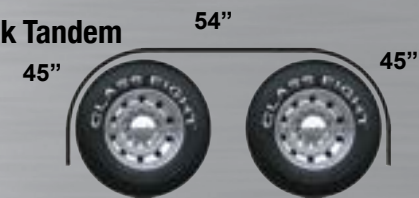

150" Black Mirror Finish Smooth Extra Long Tandem 54" Spread

FS15054S14BMF

150" Smooth Stainless Extra Long Fender
(Curled Under)
(48" - 54" - 48") 14 GA, Fits 43" Tires
180 lbs per set

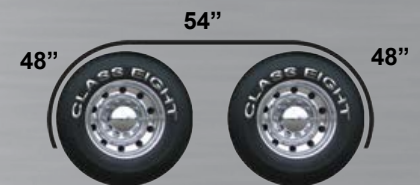

FS15054S14ELFBMF

150" Smooth Stainless Extra Long Front & Back Fender
(Straight Down)
(48" - 54" - 48") 14 GA, Fits 43" Tires
180 lbs per set

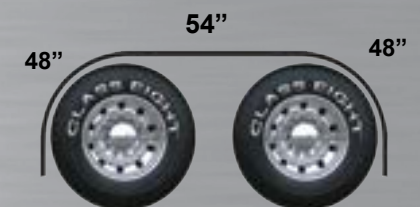



Black Mirror Finish Single Axle Fenders



80" Black Mirror Finish Single Axle

FS180S14BMF 80" Black Mirror Finish Single Axle Fender, Rolled Edge
14 GA 92 lbs per set
Fits 43" Tire
***For 46.5", Add HP to Part #**



92" Black Mirror Finish Single Axle

FS192S14ELFBMF 92" Black Mirror Finish Single Axle Fender, Rolled Edge
14 GA 104 lbs per set
Fits 43" Tire



96" Black Mirror Finish Single Axle

FS196S14BMF 96" Black Mirror Finish Single Axle Fender, Rolled Edge
14 GA 110 lbs per set
Fits 43" Tire



96" Black Mirror Finish Extra Long Single Axle

FS196S14ELFBMF 96" Black Mirror Finish Single Axle Fender Extra Long
Front & Back, Rolled Edge 14 GA
110 lbs per set Fits 43" Tire





Black Mirror Finish Half Fender Mounting Kit



FMH200BSHD



	(QTY)		
	(2)	F200SBMF	12 GA Black 304 Mirror Finish Heavy Duty Triangle Side Mount
	(2)	F52	Post Mount Threaded
	(2)	F52U	Post Mount Unthreaded



6 Centre Bracket Options - One Price

FMH200BSHD-1



QTY: 2
FML230 & FMR230
Adjustable Centre Bracket
Left & Right 8 - 12" Height
All necessary hardware included

FMH200BSHD-2



QTY: 2
FMM360-9 (4" Version available)
360° Swivel Pad Mount Bracket
Universal Fit 9" Off set
All necessary hardware included

FMH200BSHD-3

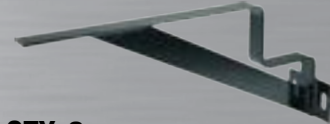

QTY: 2
FM230
Solid Centre Bracket
Universal Fit 12 3/4" Height
All necessary hardware included

FMH200SBHD-4



QTY: 2
FML230FL & FMR230FL
Height 12"
Left & Right Bracket
All necessary hardware included

FMH200BSHD-5



QTY: 2
FM235LH & FM235RH
7 1/2" Height
Left & Right Bracket
All necessary hardware included

FMH200BSHD-6



QTY: 2
FM360-9 (4" Version available)
360° Swivel Mount Bracket
Universal Fit 9" Off set
All necessary hardware included

FHH200BSHD

(Hardware Kit Included with Mounting Kit)

	(QTY)	
	(6)	Backing Plate
	(12)	Triangle Bolt & Washer
	(2)	SS Clamp for Triangle Bolt
	(2)	Fine Thread F52 Bolt



Black Mirror Finish Tandem Mounting Kit

FMT200BSHD



(QTY)



(4)

F200SBMF

**12 GA 304 Black Mirror Finish
Heavy Duty
Triangle Side Mount**



(4)

F52

**Post Mount Threaded
or**

(4)

F52U

Post Mount Unthreaded



6 Centre Bracket Options - One Price

FMT200BSHD-1



QTY: 2

FML230 & FMR230

Adjustable Centre Bracket

Left & Right 8 - 12" Height

All necessary hardware included

FMT200BSHD-2



QTY: 2

FMM360-9 (4" Version available)

360° Swivel Pad Mount Bracket

Universal Fit 9" Off set

All necessary hardware included

FMT200BSHD-3

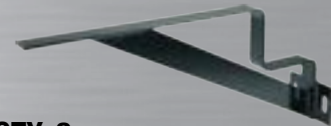

QTY: 2

FM230

Solid Centre Bracket

Universal Fit 12 3/4" Height

All necessary hardware included

FMT200BSHD-4



QTY: 2

FML230FL & FMR230FL

Height 12"

Left & Right Bracket

All necessary hardware included

FMT200BSHD-5



QTY: 2

FM235LH & FM235RH

7 1/2" Height

Left & Right Bracket

All necessary hardware included

FMT200BSHD-6



QTY: 2

FM360-9 (4" Version available)

360° Swivel Mount Bracket

Universal Fit 9" Off set

All necessary hardware included

FHT200BSHD

(Hardware Kit Included with Mounting Kit)

(QTY)

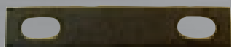

(12)

Backing Plate



(24)

Triangle Bolt & Washer



(4)

SS Clamp for Triangle Bolt



(4)

Fine Thread F52 Bolt

Black Mirror Finish Single Axle Mounting Kit



FMR200BSHD



- | | (QTY) | |
|---|-------|--|
|  | (4) | F200SBMF 12 GA 304 Black Mirror Finish Heavy Duty Triangle Side Mount |



- | | (QTY) | |
|--|-------|-----------------------------------|
| | (4) | F52 Post Mount Threaded |
| | (4) | F52U Post Mount Unthreaded |



FHR200BSHD

(Hardware Kit Included with Mounting Kit)

- | | (QTY) | |
|---|-------|---|
|  | (4) | SS Clamp for Triangle Mount |
|  | (24) | Triangle Mount Bolt & Washer |
|  | (4) | Fine Thread F52 Bolt |
|  | (12) | Backing Plate |

.125" Thick Wall Aluminum Fenders



* Paintable Aluminum Fenders, Paint not included

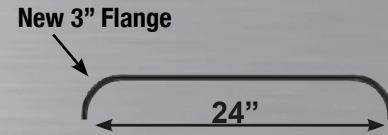

144" Thick Wall Aluminum Tandem Fender

FS14454TWA

144" Smooth Thick Wall Aluminum Tandem Fender
(Curled Under)
(45" - 54" - 45") .125" 89 lbs per set
Fits 43" Tires



FS14454TWAELF

144" Smooth Thick Wall Aluminum Tandem
Extra Long (Straight Down)
(45" - 54" - 45") .125" 89 lbs per set
Fits 43" or 46.5" Tires

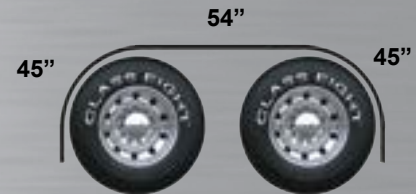

80" Thick Wall Aluminum Half Fender

FS80TWAELF

80" Smooth Thick Wall Aluminum Half Fender
Extra Long Front
(49" - 31") .125" 50 lbs per set
Fits 43" Tires

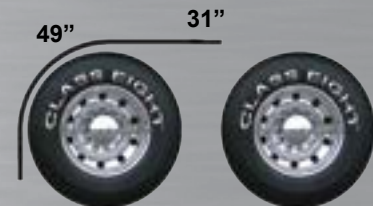

80" Thick Wall Aluminum Single Axle Fender

FS180TWA

80" Thick Wall Aluminum Single Axle Fender
.125" 50 lbs per set
Fits 43" Tires
*For 46.5" Add HP to Part #



96" Thick Wall Aluminum Single Axle Fender

FS196TWA

96" Smooth Thick Wall Aluminum Single Axle Fender
.125" 60 lbs per set
Fits 43" Tires



FS196TWAELF

96" Smooth Thick Wall Aluminum Single Axle Fender
Extra Long Front (Straight Down)
.125" 60 lbs per set
Fits 43" Tires



.090" Smooth Aluminum Half Fenders

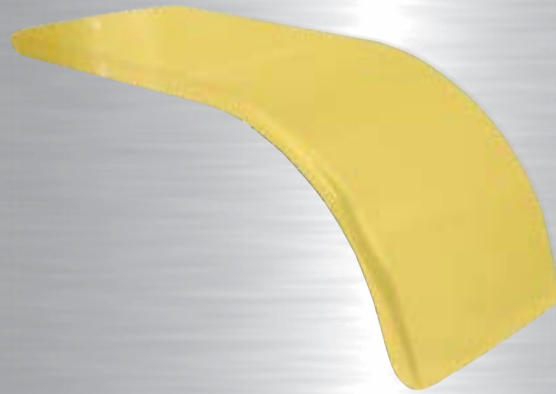

* Paintable Aluminum Fenders, Paint not included

New 3" Flange

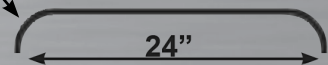

60" Smooth Aluminum Half Fender

FS60A

60" Smooth Aluminum Half Fender, Rolled Edge
(35" - 25") .090", 29 lbs per set
Fits 43" or 46.5" Tires



66" Smooth Aluminum Half Fender

FS66A

66" Smooth Aluminum Half Fender, Rolled Edge
(35" - 31") .090" 32 lbs per set
Fits 43" or 46.5" Tires

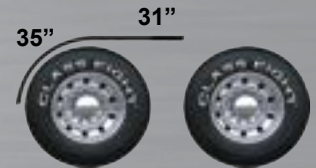

72" Smooth Aluminum Half Fender

FS72A

72" Smooth Aluminum Half Fender, Rolled Edge
(35" - 37") .090" 35 lbs per set
Fits 43" or 46.5" Tires

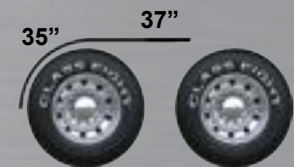



.090" Smooth Aluminum Tandem & Single Axle Fenders



* Paintable Aluminum Fenders, Paint not included

New 3" Flange

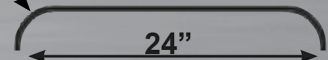

132" Smooth Aluminum Tandem, 54" Spread

FS13254A101

132" Smooth Aluminum Tandem Fender, Rolled Edge
(39" - 54" - 39") .090, Fits 43" Tire
(63 lbs per set)

FS13254A105

132" Smooth Aluminum Tandem Fender,
Rolled Edge
(39" - 54" - 39").090, (63 lbs per set)
Fits 43" Tire



66" Smooth Aluminum Single Axle

FS166A

66" Smooth Aluminum Single Axle Fender,
Rolled Edge
.090, Fits 43" Tire
(32 lbs per set)



80" Smooth Aluminum Single Axle

FS180A

80" Smooth Aluminum Single Axle Fender,
Rolled Edge
.090, Fits 43" Tire
(38 lbs per set)



FS180A51

80" Smooth Aluminum Single Axle Fender,
Rolled Edge
.090, Fits 43" Tire
(38 lbs per set)



New Product - Construction Fenders



Reinforced Back



64" Diamond Plate Construction Half Fender

FD177A

64" Diamond Plate Half Fender
.125 Fits 43" or 46.5" Tires
(51 lbs per set)

Mounting Kit Options

FMH177

Half Fender Mounting Kit



FMH177U

Half Fender Mounting Kit W/ U-Bolt





Mirror Finish Quarter Fenders

All Quarter Fenders Below Include the F200SBHD 12 GA Triangle Mounts, See Page 63

All Quarter Fenders Include the F52 Post Mount, See Page 64

QF31S14MF

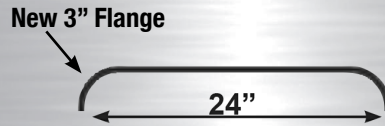

Mirror Finish Stainless Quarter Fender

52 lbs per set

31" 14 GA

QF34S14MF

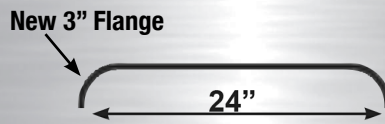

Mirror Finish Stainless Quarter Fender

57 lbs per set

34" 14 GA

QF38S14MF

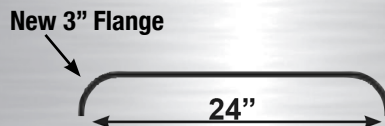

Mirror Finish Stainless Quarter Fender (Curled under)

62 lbs per set

38" 14 GA

QF38S14ELFMF

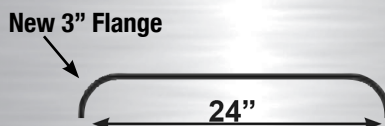

Mirror Finish Stainless Quarter Fender (Straight down)

62 lbs per set

38" 14 GA

The Affordable 304 Perfect Mirror Finish Fenders

Your One Stop Shop for Truck Fenders, Brackets & Accessories

Mirror Finish Half Fenders



New 3" Flange

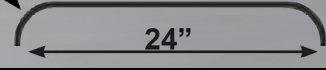

68" Mirror Finish Half Fenders

FS68S14MF 68" Mirror Finish Half Fender, Rolled Edge
(35" - 33") 14 GA 76 lbs per set
Fits 43" or 46.5" Tires

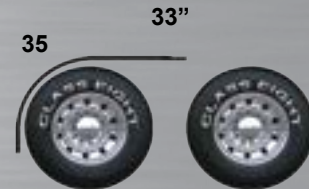

FS68S14LFMF 68" Mirror Finish Long Front Half Fender, Rolled Edge
(41" - 27") 14 GA 76 lbs per set
Fits 43" or 46.5" Tire



72" Mirror Finish Half Fenders

FS72S14MF 72" Mirror Finish Half Fender, Rolled Edge
(35" - 37") 14 GA, 83 lbs per set
Fits 43" or 46.5" Tires



FS72S14LFMF 72" Mirror Finish Long Front Half Fender, Rolled Edge
(41" - 31") 14 GA, 83 lbs per set
Fits 43" or 46.5" Tires



80" Mirror Finish Half Fenders

FS80S14MF 80" Mirror Finish Half Fender, Rolled Edge
(49" - 31") 14 GA, 92 lbs per set
Fits 43" or 46.5" Tires



FS80S14ELFMF 80" Mirror Finish Half Fender, Extra Long Front
Rolled Edge (49" - 31") 14 GA, 92 lbs per set
Fits 43" or 46.5" Tires

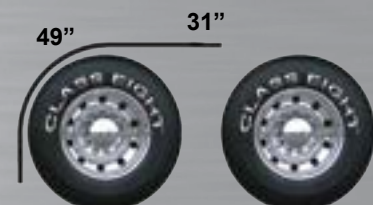

The Affordable 304 Perfect Mirror Finish Fenders

905 760 8103

www.class8mfg.com

13



Mirror Finish Tandem Fenders



New 3" Flange

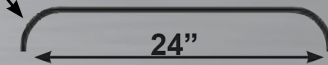

132" Mirror Finish Tandem, 54" Spread

FS13254S14MF

132" Mirror Finish Tandem Fender, Rolled Edge
(39" - 54" - 39") 14 GA, 152 lbs per set
Fits 43" Tire



144" Mirror Finish Tandem, 54" Spread

FS14454S14MF

144" Mirror Finish Tandem Fender, Rolled Edge
(Curled Under)
(45" - 54" - 45") 14 GA, 166 lbs per set
Fits 43" Tire

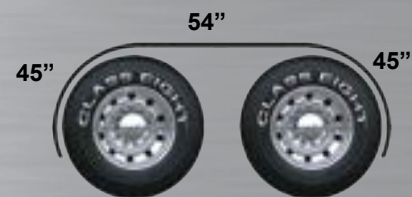

FS14454S14ELFMF

144" Mirror Finish Extra Long Front and Back Tandem
Fender, Rolled Edge (Straight Down)
(45" - 54" - 45") 14 GA, 166 lbs per set
Fits 43" Tire



150" Smooth Extra Long Tandem, Straight Down, 54" Spread

FS15054S14ELFMF

150" Smooth Stainless Extra Long Front & Back Fender
(Straight Down)
(48" - 54" - 48") 14 GA, Fits 43" Tires
180 lbs per set



150" Smooth Extra Long Tandem, Curled Under, 54" Spread

FS15054S14MF

150" Smooth Stainless Extra Long Fender
(Curled Under)
(48" - 54" - 48") 14 GA, Fits 43" Tires
180 lbs per set

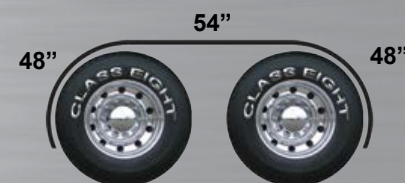

The Affordable 304 Perfect Mirror Finish Fenders

Your One Stop Shop for Truck Fenders, Brackets & Accessories

Mirror Finish Single Axle Fenders

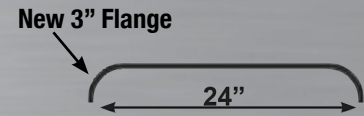

80" Mirror Finish Single Axle

FS180S14MF 80" Mirror Finish Single Axle Fender, Rolled Edge
 14 GA 92 lbs per set
 Fits 43" Tire
 *For 46.5", Add **HP** to Part #



92" Mirror Finish Single Axle

FS192S14ELFMF 92" Mirror Finish Single Axle Fender, Rolled Edge
 14 GA 105 lbs per set
 Fits 43" Tire



96" Mirror Finish Single Axle

FS196S14MF 96" Mirror Finish Single Axle Fender, Rolled Edge
 14 GA 110 lbs per set
 Fits 43" Tire



96" Mirror Finish Extra Long Single Axle

FS196S14ELFMF 96" Mirror Finish Single Axle Fender Extra Long
 Front & Back, Rolled Edge 14 GA
 110 lbs per set Fits 43" Tire



The Affordable 304 Perfect Mirror Finish Fenders

905 760 8103

www.class8mfg.com

Mirror Finish Single Axle Mounting Kit

FMR200SHD

- (QTY)
 (4) **F200SBHD 12 GA 304 Mirror Finish Heavy Duty Triangle Side Mount**

- (QTY)
 (4) **F52 Post Mount Threaded**



FHR200SHD (Hardware Kit Included with Mounting Kit)

- (QTY)
 (4) **SS Clamp for Triangle Mount**
-  (24) **Triangle Mount Bolt & Washer**
-  (4) **Fine Thread F52 Bolt**
-  (12) **Backing Plate**

Mirror Finish Tandem Mounting Kit



FMT200SHD

- (QTY)
(4) F200SBHD 12 GA 304 Mirror Finish Heavy Duty Triangle Side Mount
- 
- (4) F52 Post Mount Threaded
- 

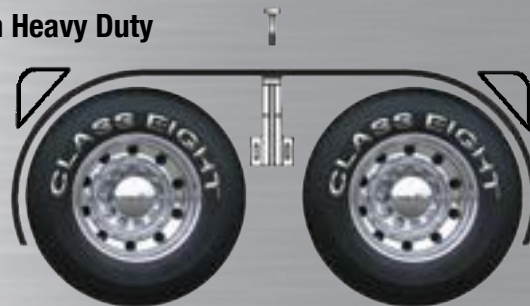

6 Centre Bracket Options - One Price

FMT200SHD-1



QTY: 2
FML230 & FMR230
Adjustable Centre Bracket
Left & Right 8 - 12" Height
All necessary hardware included

FMT200SHD-2



QTY: 2
FMM360-9 (4" Version available)
360° Swivel Pad Mount Bracket
Universal Fit 9" Off set
All necessary hardware included

FMT200SHD-3

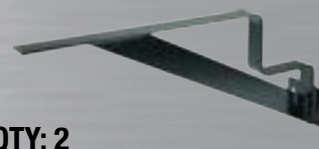

QTY: 2
FM230
Solid Centre Bracket
Universal Fit 12 3/4" Height
All necessary hardware included

FMT200SHD-4



QTY: 2
FML230FL & FMR230FL
Height 12"
Left & Right Bracket
All necessary hardware included

FMT200SHD-5



QTY: 2
FM235LH & FM235RH
7 1/2" Height
Left & Right Bracket
All necessary hardware included





FMT200SHD-6



QTY: 2
FM360-9 (4" Version available)
360° Swivel Mount Bracket
Universal Fit 9" Off set
All necessary hardware included

FHT200SHD

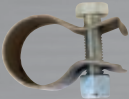
(Hardware Kit Included with Mounting Kit)

- (QTY)
(12) Backing Plate
- 
- (24) Triangle Bolt & Washer
- 
- (4) SS Clamp for Triangle Bolt
- 
- (4) Fine Thread F52 Bolt
- 

Mirror Finish Half Fender Mounting Kit

FMH200SHD

(QTY)



(2) F200SBHD 12 GA 304 Mirror Finish Heavy Duty Triangle Side Mount



(2) F52 Post Mount Threaded



6 Centre Bracket Options - One Price

FMH200SHD-1



QTY: 2
FML230 & FMR230
Adjustable Centre Bracket
Left & Right 8 - 12" Height
All necessary hardware included

FMH200SHD-2



QTY: 2
FMM360-9 (4" Version available)
360° Swivel Pad Mount Bracket
Universal Fit 9" Off set
All necessary hardware included

FMH200SHD-3



QTY: 2
FM230
Solid Centre Bracket
Universal Fit 12 3/4" Height
All necessary hardware included

FMH200SHD-4



QTY: 2
FML230FL & FMR230FL
Height 12"
Left & Right Bracket
All necessary hardware included

FMH200SHD-5



QTY: 2
FM235LH & FM235RH
7 1/2" Height
Left & Right Bracket
All necessary hardware included

FMH200SHD-6



QTY: 2
FM360-9 (4" Version available)
360° Swivel Mount Bracket
Universal Fit 9" Off set
All necessary hardware included

FHH200SHD

(Hardware Kit Included with Mounting Kit)

(QTY)

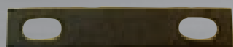

(6) Backing Plate



(12) Triangle Bolt & Washer



(2) SS Clamp for Triangle Bolt



(2) Fine Thread F52 Bolt

Half Fender Hidden Bracket Kits

Use Chart below for your Fender Mounting Requirements

Year	Truck Make	Suspension	Tire Size	Part Number
Any	Kenworth	AG 380	22.5 Low/Tall, 24.5 Low	HB-PFAH-*
Any	Kenworth	AG 380	24.5 Tall Rubber	HB-PFAHPPH-*
2005+	Kenworth	AG400L	22.5 Tall/ 24.5 Low	HB-05LAH-*
2005+	Kenworth	AG400L	22.5 Low Profile	HB-05LALPH-*
Any	Peterbilt	Flex Air	22.5 Low/Tall, 24.5 Low	HB-PFAH-*
Any	Peterbilt	Flex Air	24.5 Tall Rubber	HB-PFAHPPH-*
2005+	Peterbilt	Low Air	24.5 Tall Rubber	HB-05LAHPPH-*
2005+	Peterbilt	Low Air	22.5 Tall/ 24.5 Low	HB-05LAH-*
2005+	Peterbilt	Low Air	22.5 Low Profile	HB-05LALPH-*
2004 or older	Peterbilt	Low Air	Any Tire Size	HB-04PLAH-*
Any	Peterbilt	Air Leaf	22.5 Low/Tall, 24.5 Low	HB-ALH-*
Any	Peterbilt	Air Leaf	24.5 Tall Rubber	HB-ALHPPH-*
Any	Peterbilt	Air Trac	Any Tire Size	HB-ATH-*

6 Centre Bracket Options

-1



QTY: 2
FML230 & FMR230
Adjustable Centre Bracket
Left & Right 8 - 12" Height
All necessary hardware included

-2



QTY: 2
FMM360-9 (4" Version available)
360° Swivel Pad Mount Bracket
Universal Fit 9" Off set
All necessary hardware included

-3



QTY: 2
FM230
Solid Centre Bracket
Universal Fit 12 3/4" Height
All necessary hardware included

-6



QTY: 2
FM360-9 (4" Version available)
360° Swivel Mount Bracket
Universal Fit 9" Off set
All necessary hardware included

-7



HB-5DS & HB-5PS
ONLY FOR FLEX AIR
SUSPENSION
All necessary hardware included

-8



HB-6DS & HB-6PS
ONLY FOR FLEX AIR
SUSPENSION
All necessary hardware included



Tandem Hidden Bracket Kits

Use Chart below for your Fender Mounting Requirements

Year	Truck Make	Suspension	Tire Size	Part Number
Any	Kenworth	AG 380 22.5 Low/Tall	24.5 Low	HB-PFAT-*
Any	Kenworth	AG 380	24.5 Tall Rubber	HB-PFAHPT-*
2005+	Kenworth	AG400L	22.5 Tall/ 24.5 Low	HB-05LAT-*
2005+	Kenworth	AG400L	22.5 Low Profile	HB-05LALPT-*
Any	Peterbilt	Flex Air	22.5 Tall/ 24.5 Low	HB-PFAT-*
Any	Peterbilt	Flex Air	24.5 Tall Rubber	HB-PFAHPT-*
2005+	Peterbilt	Low Air	24.5 Tall Rubber	HB-05LAHPT-*
2005+	Peterbilt	Low Air	22.5 Tall/ 24.5 Low	HB-05LAT-*
2005+	Peterbilt	Low Air	22.5 Low Profile	HB-05LALPT-*
2004 or older	Peterbilt	Low Air	Any Tire Size	HB-04PLAT-*
Any	Peterbilt	Air Leaf	22.5 Low/Tall, 24.5 Low	HB-ALT-*
Any	Peterbilt	Air Leaf	24.5 Tall Rubber	HB-ALHPT-*
Any	Peterbilt	Air Trac	Any Tire Size	HB-ATT-*

6 Centre Bracket Options

-1



QTY: 2
FML230 & FMR230
 Adjustable Centre Bracket
 Left & Right 8 - 12" Height
 All necessary hardware included

-2



QTY: 2
FMM360-9 (4" Version available)
 360° Swivel Pad Mount Bracket
 Universal Fit 9" Off set
 All necessary hardware included

-3



QTY: 2
FM230
 Solid Centre Bracket
 Universal Fit 12 3/4" Height
 All necessary hardware included

-6



QTY: 2
FM360-9 (4" Version available)
 360° Swivel Mount Bracket
 Universal Fit 9" Off set
 All necessary hardware included

-7



HB-5DS & HB-5PS
ONLY FOR FLEX AIR
SUSPENSION
 All necessary hardware included

-8



HB-6DS & HB-6PS
ONLY FOR FLEX AIR
SUSPENSION
 All necessary hardware included

Single Axle Fender Hidden Bracket Kits

Use Chart below for your Fender Mounting Requirements

This Chart mounts FRONT Axle Only

Year	Truck Make	Suspension	Tire Size	Part Number
Any	Kenworth	AG 380	22.5 Low/Tall, 24.5 Low	HB-PFAR
Any	Kenworth	AG 380	24.5 Tall Rubber	HB-PFAHPR
2005+	Kenworth	AG400L	22.5 Low Profile	HB-05LALPR
2005+	Kenworth	AG400L	22.5 Low/Tall, 24.5 Low	HB-05LAR
Any	Peterbilt	Flex Air	22.5 Low/Tall, 24.5 Low	HB-PFAR
Any	Peterbilt	Flex Air	24.5 Tall Rubber	HB-PFAHPR
2005+	Peterbilt	Low Air	24.5 Tall Rubber	HB-05LAHPR
2005+	Peterbilt	Low Air	22.5 Tall/ 24.5 Low	HB-05LAR
2005+	Peterbilt	Low Air	22.5 Low Profile	HB-05LALPR
2004 or older	Peterbilt	Low Air	Any Tire Size	HB-04LAR
Any	Peterbilt	Air Leaf	22.5 Low/Tall, 24.5 Low	HB-ALR
Any	Peterbilt	Air Leaf	24.5 Tall Rubber	HB-ALHRP
Any	Peterbilt	Air Trac	Any Tire Size	HB-ATR



Single Axle Fender Hidden Bracket Kits

Use Chart below for your Fender Mounting Requirements

This Chart mounts 4 Fenders

Year	Truck Make	Suspension	Tire Size	Part Number
Any	Kenworth	AG 380	22.5 Low/Tall, 24.5 Low	HB-PFAR-4
Any	Kenworth	AG 380	24.5 Tall Rubber	HB-PFAHPR-4
2005+	Kenworth	AG400L	22.5 Low Profile	HB-05LALPR-4
2005+	Kenworth	AG400L	22.5 Low/Tall, 24.5 Low	HB-05LAR-4
Any	Peterbilt	Flex Air	22.5 Low/Tall, 24.5 Low H	B-PFAR-4
Any	Peterbilt	Flex Air	24.5 Tall Rubber	HB-PFAHPR-4
2005+	Peterbilt	Low Air	24.5 Tall Rubber	HB-05LAHPR-4
2005+	Peterbilt	Low Air	22.5 Tall/ 24.5 Low	HB-05LAR-4
2005+	Peterbilt	Low Air	22.5 Low Profile	HB-05LALPR-4
2004 or older	Peterbilt	Low Air	Any Tire Size	HB-04LAR-4
Any	Peterbilt	Air Leaf	22.5 Low/Tall, 24.5 Low	HB-ALR-4
Any	Peterbilt	Air Leaf	24.5 Tall Rubber	HB-ALHRP-4
Any	Peterbilt	Air Trac	Any Tire Size	HB-ATR-4

Quarter Fenders



All Quarter Fenders Below Include F200SB 14 GA Triangle Mounts, See Page 63

All Quarter Fenders Do Not Include the F52 Post Mount, See Page 64

QF24S



New 3" Flange

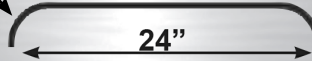

Stainless Quarter Fender

37 lbs per set

(Fits All Size Tires)

24" 16 GA

QF27S



New 3" Flange

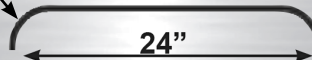

Stainless Quarter Fender

40 lbs per set

(Fits All Size Tires)

27" 16 GA

QF31S



New 3" Flange

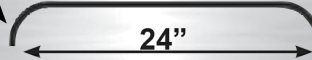

Stainless Quarter Fender

43 lbs per set

(Fits All Size Tires)

31" 16 GA

QF34S



New 3" Flange

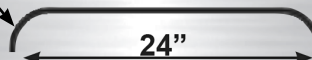

Stainless Quarter Fender

46 lbs per set

(Fits All Size Tires)

34" 16 GA

905 760 8103

www.class8mfg.com

23



Quarter Fenders

All Quarter Fenders Below Include F200SB 14 GA Triangle Mounts, See Page 63

All Quarter Fenders Do Not Include the F52 Post Mount, See Page 64



QF38S14



New 3" Flange

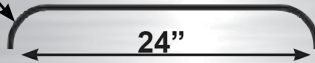

Stainless Quarter Fender (Curled Under)

58 lbs per set

38" 14 GA

QF38S14ELF



New 3" Flange

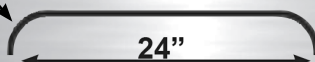

Extra Long Stainless Quarter Fender (Straight Down)

58 lbs per set

38" 14 GA

QF24BS



New 3" Flange

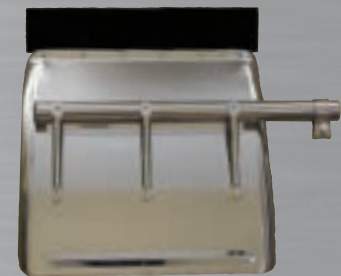
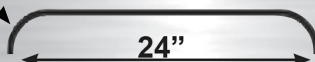

Braced Stainless Quarter Fender

37 lbs per set

24" 16 GA

QF1900P



New 3" Flange

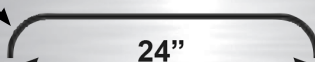

Poly Fender with Tube Brace

20 lbs per Set

24"

Smooth Half Fenders



New 3" Flange

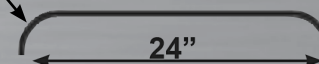

53" Cowling Fit

FS53SCF

53" Smooth Half Fender Cowling Fit
(13" - 40") 16 GA, 49 lbs per set
Fits 43" or 46.5" Tires

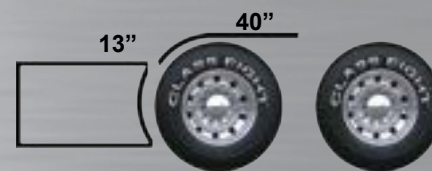

60" Smooth

FS60S

60" Smooth Half Fender, Rolled Edge
(35" - 25") 16 GA, 55 lbs per set, Fits 43" or 46.5" Tires

FS60S14

60" Smooth Half Fender, Rolled Edge
(35" - 25") 14 GA, 69 lbs per set, Fits 43" or 46.5" Tires

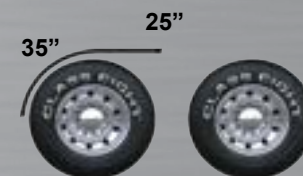

66" Smooth

FS66S

66" Smooth Half Fender, Rolled Edge
(35" - 31") 16 GA, 61 lbs per set, Fits 43" or 46.5" Tires

FS66S14

66" Smooth Half Fender, Rolled Edge
(35" - 31") 14 GA, 76 lbs per set, Fits 43" or 46.5" Tires



66" Low Profile Smooth

FS66SLP

66" Smooth Half Fender Low Profile, Rolled Edge
(39" - 27") 16 GA, 61 lbs per set, Fits 41" Tires

FS66S14LP

66" Smooth Half Fender Low Profile, Rolled Edge
(39" - 27") 14 GA, 76 lbs per set, Fits 41" Tires

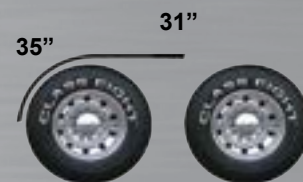

72" Smooth

FS72S

72" Smooth Half Fender, Rolled Edge
(35" - 37") 16 GA, 66 lbs per set, Fits 43" or 46.5" Tires

FS72S14

72" Smooth Half Fender, Rolled Edge
(35" - 37") 14 GA, 83 lbs per set, Fits 43" or 46.5" Tires

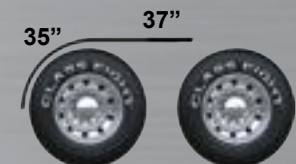



Smooth Long Front Half Fenders



FS80SLF

New 3" Flange

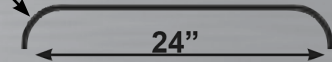

66" Smooth Long Front

FS66SLF

66" Smooth Long Front Half Fender, Rolled Edge
(41" - 25") 16 GA, 61 lbs per set, Fits 43" or 46.5" Tires

FS66S14LF

66" Smooth Long Front Half Fender, Rolled Edge
(41" - 25") 14 GA, 76 lbs per set, Fits 43" or 46.5" Tires

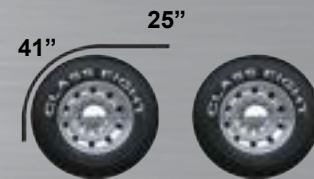

72" Smooth Long Front

FS72SLF

72" Smooth Long Front Half Fender, Rolled Edge
(41" - 31") 16 GA, 66 lbs per set, Fits 43" or 46.5" Tires

FS72S14LF

72" Smooth Long Front Half Fender, Rolled Edge
(41" - 31") 14 GA, 83 lbs per set, Fits 43" or 46.5" Tires



80" Smooth Long Front

FS80SLF

80" Smooth Long Front Half Fender, Rolled Edge
(41" - 39") 16 GA, 74 lbs per set, Fits 43" or 46.5" Tires

FS80S14LF

80" Smooth Long Front Half Fender, Rolled Edge
(41" - 39") 14 GA, 92 lbs per set, Fits 43" or 46.5" Tires

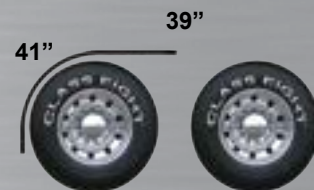

80" Smooth Extra Long Front

FS80S14ELF

80" Smooth Extra Long Front Half Fender, Rolled Edge
(41" - 45") 14 GA, 99 lbs per set, Fits 43" or 46.5" Tires

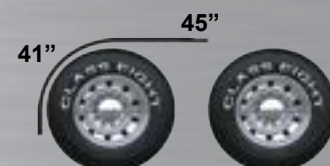

3 Rib Long Front Half Fenders

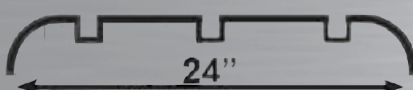

66" Ribbed Long Front

FR66SLF

66" Stainless Ribbed Long Front Half Fender, Rolled Edge
(41" - 25") 16 GA, 61 lbs per set, Fits 43" or 46.5" Tires

FR66ALF

66" Aluminum Ribbed Long Front Half Fender, Rolled Edge
(41" - 25") 0.090, 32 lbs per set, Fits 43" or 46.5" Tires

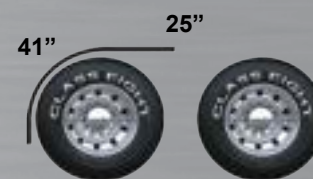

72" Ribbed Long Front

FR72SLF

72" Stainless Ribbed Long Front Half Fender, Rolled Edge
(41" - 31") 16 GA, 66 lbs per set, Fits 43" or 46.5" Tires

FR72ALF

72" Aluminum Ribbed Long Front Half Fender, Rolled Edge
(41" - 31") 0.090, 35 lbs per set, Fits 43" or 46.5" Tires



80" Ribbed Long Front

FR80SLF

80" Stainless Ribbed Long Front Half Fender, Rolled Edge
(41" - 39") 16 GA, 74 lbs per set
Fits 43" or 46.5" Tires

FR80ALF

80" Aluminum Ribbed Long Front Half Fender, Rolled Edge
(41" - 39") 0.090, 38 lbs per set
Fits 43" or 46.5" Tires

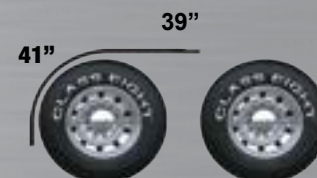



3 Rib Half Fenders

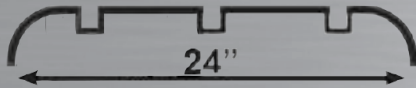
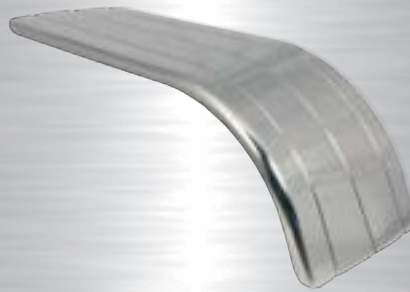

60" Ribbed

FR60S 60" Stainless Ribbed Half Fender, Rolled Edge
(35" - 25") 16 GA, 55 lbs per set, Fits 43" or 46.5" Tires

FR60A 60" Aluminum Ribbed Half Fender, Rolled Edge
(35" - 25") 0.090, 29 lbs per set, Fits 43" or 46.5" Tires

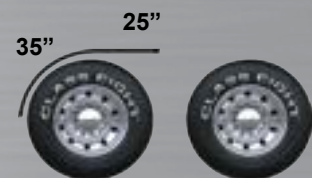

66" Ribbed

FR66S 66" Stainless Ribbed Half Fender, Rolled Edge
(35" - 31") 16 GA, 61 lbs per set, Fits 43" or 46.5" Tires

FR66A 66" Aluminum Ribbed Half Fender, Rolled Edge
(35" - 31") 0.090, 32 lbs per set, Fits 43" or 46.5" Tires



80" Ribbed

FR80S 80" Stainless Ribbed Half Fender, Rolled Edge
(35" - 45") 16 GA, 74 lbs per set, Fits 43" or 46.5" Tires

FR80A 80" Aluminum Ribbed Half Fender, Rolled Edge
(35" - 45") 0.090, 38 lbs per set, Fits 43" or 46.5" Tires

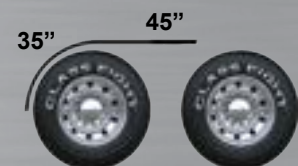



3 Rib Half Fenders

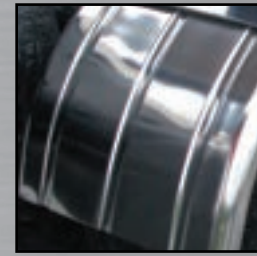

120" Ribbed

FR120S

120" Stainless Ribbed Half Fender, Rolled Edge
(35" - 85") 16 GA, 112 lbs per set, Fits 43" or 46.5" Tires

FR120A

120" Aluminum Ribbed Half Fender, Rolled Edge
(35" - 85") 0.090, 58 lbs per set, Fits 43" or 46.5" Tires

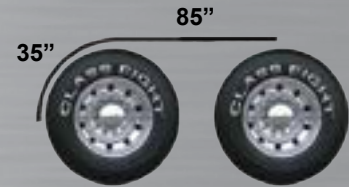

125" Ribbed

FR125S

125" Stainless Ribbed Half Fender, Rolled Edge
(27" - 98") 16 GA, 116 lbs per set, Fits 43" or 46.5" Tires

FR125A

125" Aluminum Ribbed Half Fender, Rolled Edge
(27" - 98") 0.090, 60 lbs per set, Fits 43" or 46.5" Tires



142" Ribbed

FR142S

142" Stainless Ribbed Half Fender, Rolled Edge
(27" - 115") 16 GA, 132 lbs per set, Fits 43" or 46.5" Tires

FR142A

142" Aluminum Ribbed Half Fender, Rolled Edge
(27" - 115") 0.090, 68 lbs per set, Fits 43" or 46.5" Tires

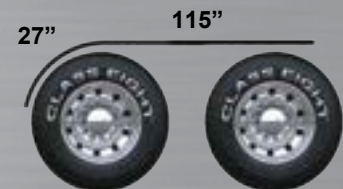



3 Rib Half Fenders

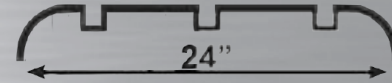

144" Ribbed

FR144S

**144" Stainless Ribbed Half Fender Rolled Edge
(27" - 117") 16 GA, 134 lbs per set, Fits 43" or 46.5" Tires**

FR144A

**144" Aluminum Ribbed Half Fender Rolled Edge
(27" - 117") 0.090, 69 lbs per set, Fits 43" or 46.5" Tires**



150" Ribbed

FR150S

**150" Stainless Ribbed Half Fender Rolled Edge
(27" - 123") 16 GA, 140 lbs per set, Fits 43" or 46.5" Tires**

FR150A

**150" Aluminum Ribbed Half Fender Rolled Edge
(27" - 123") 0.090, 72 lbs per set, Fits 43" or 46.5" Tires**

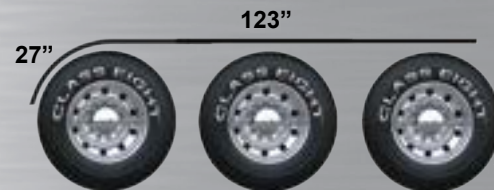

4 Rib Half Fenders

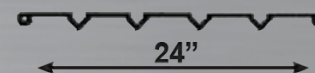

60" 4 Ribbed

FFR60S

60" Stainless Ribbed Half Fender, Beaded Edge
(35" - 25") 18 GA, 46 lbs per set, Fits 43" or 46.5" Tires

FFR60G

60" Galvanized Ribbed Half Fender, Beaded Edge
(35" - 25") 18 GA, 50 lbs per set, Fits 43" or 46.5" Tires

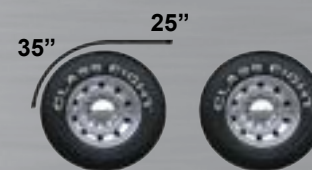

66" 4 Ribbed

FFR66S

66" Stainless Ribbed Half Fender, Beaded Edge
(35" - 31") 18 GA, 51 lbs per set, Fits 43" or 46.5" Tires

FFR66G

66" Galvanized Ribbed Half Fender, Beaded Edge
(35" - 31") 18 GA, 56 lbs per set, Fits 43" or 46.5" Tires



80" 4 Ribbed

FFR80S

80" Stainless Ribbed Half Fender, Beaded Edge
(35" - 45") 18 GA, 62 lbs per set, Fits 43" or 46.5" Tires

FFR80G

80" Galvanized Ribbed Half Fender, Beaded Edge
(35" - 45") 18 GA, 66 lbs per set, Fits 43" or 46.5" Tires

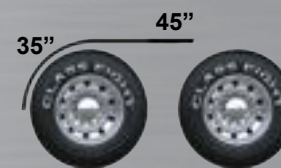

120" 4 Ribbed

FFR120S

120" Stainless Ribbed Half Fender, Beaded Edge
(35" - 85") 18 GA, 92 lbs per set, Fits 43" or 46.5" Tires

FFR120G

120" Galvanized Ribbed Half Fender, Beaded Edge
(35" - 85") 18 GA, 99 lbs per set, Fits 43" or 46.5" Tires





Smooth Tandem Fenders

New 3" Flange

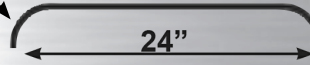

132" Smooth Tandem, 54" Spread

FS13254S

132" Smooth Tandem Fender, Rolled Edge
(39" - 54" - 39") 16 GA, Fits 43" Tire

*For 46.5", Add **HP** to Part # (122 lbs per set)

FS13254S14

132" Smooth Tandem Fender, Rolled Edge
(39" - 54" - 39") 14 GA, Fits 43" Tire

*For 46.5", Add **HP** to Part # (152 lbs per set)

FS13254S14LP

132" Smooth Low Pro Tandem Fender, Rolled Edge
(39" - 54" - 39") 14 GA, (152 lbs per set)
Fits 41" Tire

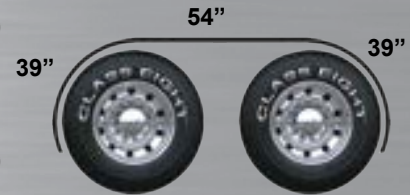

132" Smooth Tandem, 60" Spread

FS13260S

132" Smooth Tandem Fender, Rolled Edge
(36" - 60" - 36") 16 GA, Fits 43" Tire

*For 46.5", Add **HP** to Part # (122 lbs per set)

FS13260S14

132" Smooth Tandem Fender, Rolled Edge
(36" - 60" - 36") 14 GA, Fits 43" Tire

*For 46.5", Add **HP** to Part # (152 lbs per set)

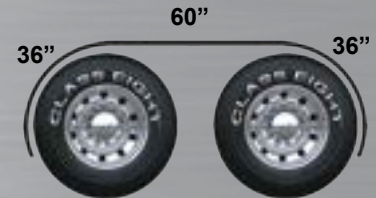

108" Smooth Tandem, 54" Spread

FS10854S

108" Smooth Tandem Fender, Rolled Edge
(18" - 54" - 36") 16 GA, Fits 43" Tire

*For 46.5", Add **HP** to Part # (101 lbs per set)

FS10854S14

108" Smooth Tandem Fender, Rolled Edge
(18" - 54" - 36") 14 GA, Fits 43" Tire

*For 46.5", Add **HP** to Part # (124 lbs per set)

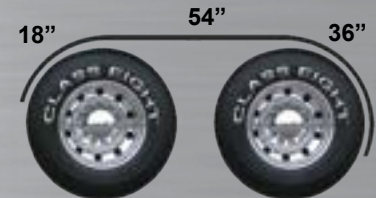

120" Smooth Tandem, 54" Spread

FS12054S

120" Smooth Tandem Fender, Rolled Edge
(35" - 54" - 31") 16 GA, Fits 43" Tire

*For 46.5", Add **HP** to Part # (111 lbs per set)

FS12054S14

120" Smooth Tandem Fender, Rolled Edge
(35" - 54" - 31") 14 GA, Fits 43" Tire

*For 46.5", Add **HP** to Part # (138 lbs per set)

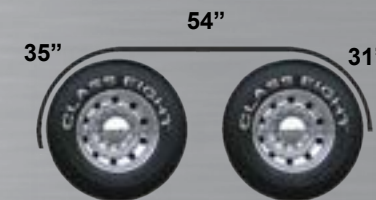

120" Smooth Tandem, 60" Spread

FS12060S

120" Smooth Tandem Fender, Rolled Edge
(35" - 60" - 25") 16 GA, Fits 43" Tire

*For 46.5", Add **HP** to Part # (111 lbs per set)

FS12060S14

120" Smooth Tandem Fender, Rolled Edge
(35" - 60" - 25") 14 GA, Fits 43" Tire

*For 46.5", Add **HP** to Part # (138 lbs per set)



3 Rib Tandem Fenders

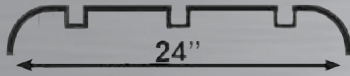

108" 3 Ribbed Tandem, 54" Spread

FR10854S

108" Stainless Ribbed Tandem Fender, Rolled Edge
(18" - 54" - 36") 16 GA, Fits 43" Tire

*For 46.5", Add **HP** to Part # (101 lbs per set)

FR10854A

108" Aluminum Ribbed Tandem Fender, Rolled Edge
(18" - 54" - 36") 0.090, Fits 43" Tire

*For 46.5", Add **HP** to Part # (52 lbs per set)



120" 3 Ribbed Tandem, 54" Spread

FR12054S

120" Stainless Ribbed Tandem Fender, Rolled Edge
(35" - 54" - 31") 16 GA, Fits 43" Tire

*For 46.5", Add **HP** to Part # (112 lbs per set)

FR12054A

120" Aluminum Ribbed Tandem Fender, Rolled Edge
(35" - 54" - 31") 0.090, Fits 43" Tire

*For 46.5", Add **HP** to Part # (58 lbs per set)

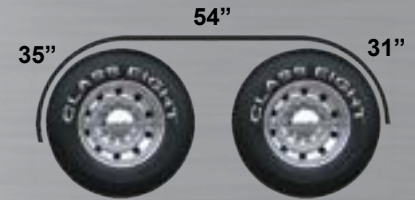

120" 3 Ribbed Tandem, 60" Spread

FR12060S

120" Stainless Ribbed Tandem Fender, Rolled Edge
(35" - 60" - 25") 16 GA, Fits 43" Tire

*For 46.5", Add **HP** to Part # (112 lbs per set)

FR12060A

120" Aluminum Ribbed Tandem Fender, Rolled Edge
(35" - 60" - 25") 0.090, Fits 43" Tire

*For 46.5", Add **HP** to Part # (58 lbs per set)





4 Rib Tandem Fenders



FFR12054S

120" 4 Ribbed Tandem, 54" Spread

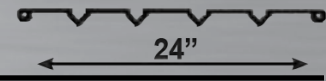

FFR12054S

120" Stainless Ribbed Tandem Fender, Beaded Edge
(35" - 54" - 31") 18 GA, Fits 43" Tire

*For 46.5", Add **HP** to Part # (92 lbs per set)

FFR12054G

120" Galvanized Ribbed Tandem Fender, Beaded Edge
(35" - 54" - 31") 18 GA, Fits 43" Tire

*For 46.5", Add **HP** to Part # (99 lbs per set)

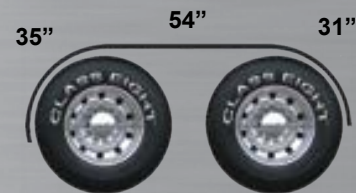

120" 4 Ribbed Tandem, 60" Spread

FFR12060S

120" Stainless Ribbed Tandem Fender, Beaded Edge
(35" - 60" - 25") 18 GA, Fits 43" Tire

*For 46.5", Add **HP** to Part # (92 lbs per set)

FFR12060G

120" Galvanized Ribbed Tandem Fender, Beaded Edge
(35" - 60" - 25") 18 GA, Fits 43" Tire

*For 46.5", Add **HP** to Part # (99 lbs per set)



Smooth Single Axle Fender



Smooth Single Axle

3" Flange

24"



FS153S

53" Smooth Stainless Single Axle Fender, Rolled Edge

16 GA, Fits 43" Tire

*For 46.5", Add **HP** to Part # (49 lbs per set)

53"



43"

FS166S

66" Smooth Stainless Single Axle Fender, Rolled Edge

16 GA, Fits 43" Tire

*For 46.5", Add **HP** to Part # (61 lbs per set)

66"



47"

FS180S

80" Smooth Stainless Single Axle Fender, Rolled Edge

16 GA, Fits 43" Tire

*For 46.5", Add **HP** to Part # (74 lbs per set)

80"



47"

FS180S14

80" Smooth Stainless Single Axle Fender, Rolled Edge

14 GA, Fits 43" Tire

*For 46.5", Add **HP** to Part # (92 lbs per set)

50"

FS196S14

96" Smooth Super Long Single Axle Fender

14 GA, Fits 43" Tire

110 lbs per set

96"



46"

FS196S14ELF

96" Smooth Super Extra Long Front and Back

Single Axle Fender

14 GA, Fits 43" Tire

110 lbs per set

96"



48"

Smooth Single Axle for 19.5" Wheels

FS160SLP

60" Smooth Stainless Single Axle for 19.5" Wheel

16 GA, Fits 36" Tire

56 lbs per set

60"



40"

FS172SLP

72" Smooth Stainless Single Axle for 19.5" Wheel

16 GA, Fits 36" Tire

66 lbs per set

72"



40"



3 Rib Single Axle Fender

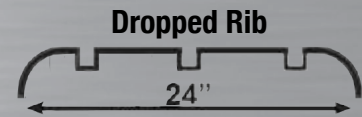

FR180S

53" Ribbed Single Axle

FR153S

53" Stainless Ribbed Single Axle Fender, Rolled Edge
16 GA, Fits 43" Tire

*For 46.5", Add **HP** to Part # (49 lbs per set)

FR153A

53" Aluminum Ribbed Single Axle Fender, Rolled Edge
0.090, Fits 43" Tire

*For 46.5", Add **HP** to Part # (25 lbs per set)



58" Ribbed Single Axle

FR158S

58" Stainless Ribbed Single Axle Fender, Rolled Edge
16 GA, Fits 43" Tire

*For 46.5", Add **HP** to Part # (54 lbs per set)

FR158A

58" Aluminum Ribbed Single Axle Fender, Rolled Edge
0.090, Fits 43" Tire

*For 46.5", Add **HP** to Part # (29 lbs per set)



3 Rib Single Axle Fender



66" Ribbed Single Axle

FR166S

66" Stainless Ribbed Single Axle Fender, Rolled Edge
16 GA, Fits 43" Tire

*For 46.5", Add **HP** to Part # (61 lbs per set)

FR166A

66" Aluminum Ribbed Single Axle Fender, Rolled Edge
0.090, Fits 43" Tire

*For 46.5", Add **HP** to Part # (32 lbs per set)



80" Ribbed Single Axle

FR180S

80" Stainless Ribbed Single Axle Fender, Rolled Edge
16 GA, Fits 43" Tire

*For 46.5", Add **HP** to Part # (67 lbs per set)

FR180A

80" Aluminum Ribbed Single Axle Fender, Rolled Edge
0.090, Fits 43" Tire

*For 46.5", Add **HP** to Part # (39 lbs per set)





4 Rib Single Axle Fender

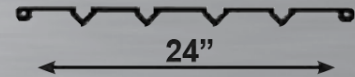

60" 4 Ribbed Single Axle, Fits 19.5" Wheels

FFR160SLP

60" Stainless Ribbed Single Axle Fender for 19.5" Wheel, Beaded Edge
18 GA, 46 lbs per set
Fits 36" Tire

FFR160GLP

60" Galvanized Ribbed Single Axle Fender for 19.5 Wheel, Beaded Edge
18 GA, 49 lbs per set
Fits 36" Tire



4 Rib Single Axle Fender

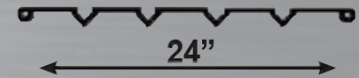

66" 4 Ribbed Single Axle

FFR166S

66" Stainless Ribbed Single Axle Fender, Beaded Edge
18 GA, Fits 43" Tire
*For 46.5", Add **HP** to Part # (51 lbs per set)

FFR166G

66" Galvanized Ribbed Single Axle Fender, Beaded Edge
18 GA, Fits 43" Tire
*For 46.5", Add **HP** to Part # (54 lbs per set)



80" 4 Ribbed Single Axle

FFR180S

80" Stainless Ribbed Single Axle Fender, Beaded Edge
18 GA, Fits 43" Tire
*For 46.5", Add **HP** to Part # (62 lbs per set)

FFR180G

80" Galvanized Ribbed Single Axle Fender, Beaded Edge
18 GA, Fits 43" Tire
*For 46.5", Add **HP** to Part # (66 lbs per set)





Single Axle Poly Fenders



5 Colours Available:

Silver #2, White #3, Orange #4, Red #5, Blue #6,

Insert Colour Code Where Noted. If no colour code is added, Black is the standard colour



Poly Single Axle

FX18025P#



Black Poly Single Axle (25" Wide)

20 lbs per set

Fits 43" Tire

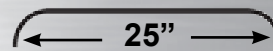

FX26S-Kit



Stainless Steel Single Axle Insert Fender Kit

All necessary hardware included

Fender not included

Fits FX18025P#

Poly Super Single Fenders



Poly Super Single



FX18019P

Black Poly Super Single Axle Fender (19.5" Wide)
17 lbs per set
Fits 36" Tire



FX18019P51

Black Poly Super Single Axle Fender (19.5" Wide)
20 lbs per set
Fits 43" Tire



Poly Locking Tool Box

TB700
Black Poly Locking Tool Box

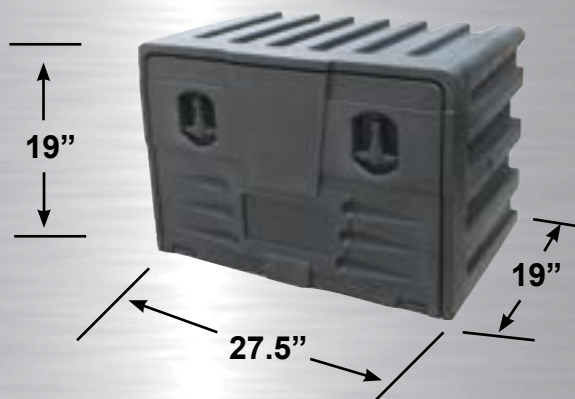

905 760 8103

www.class8mfg.com

41



Poly Adjustable Fast Fit Single Axle Kit

FX18025PHB-Kit

FX18025PHB



(QTY)

FX18025PHB

- (2) Black Poly Single Axle (27" Wide)
20 lbs per set
Fits 43" Tire



- (4) F30PHB Black Powder coated pipe with welded screw

All necessary hardware included

Half & Tandem Poly Fenders



Poly Half Fender

FX66P
 Black Poly Half Fender
 (35" - 31")
 24 lbs per Set

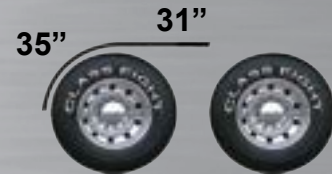
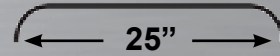

FX66P19
 Black Poly Half Fender
 (35" - 31")
 19 lbs per Set

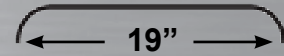

Poly Tandem Fender

FX13355P
 Black Poly Tandem Fender
 (39" - 55" - 39")
 58 lbs per Set

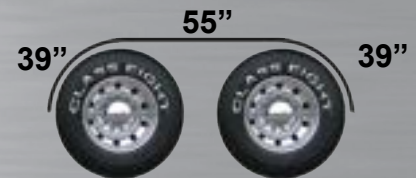

FX1335519P
 Black Poly Super Single Tandem
 Fender (19.5" Wide)
 (39" - 55" - 39")
 49 lbs per Set

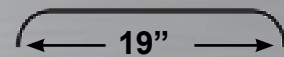



Poly Single Axle Trailer Fender



FX14510P

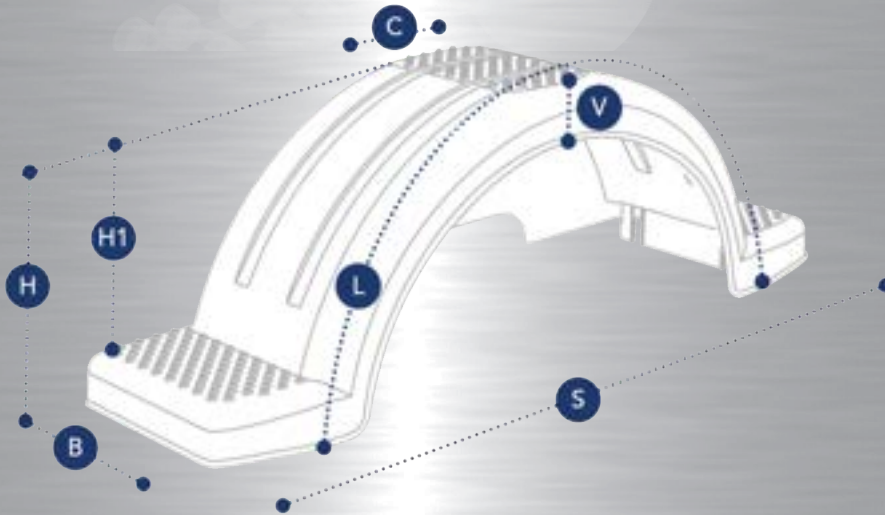

B - 10.04" S - 42.52" H - 13.39" H1 - 10.43" L - 44.88" V - 2.95" C - 7.09"

Poly Half Fender Mounting Kit



FMH50P*

* ADD HD FOR HEAVY DUTY

(QTY)

(2) F32P 32" Long, 4" Off-set Post



(2) FMM360-9



FHH50P

(Hardware Kit Included with Mounting Kit)

(QTY)

(4)

Black Plastic End Cap



(8)

Poly Bracket or * HD for Heavy Duty Adjustable Poly Bracket



FK50P



FK50PHD





(4)

Large Hex Head Bolt for Mounting Pipe



Poly Half Fender Mounting Kit

FMFPH29P

	(QTY)		
	(2)	F52P	Post Mount
	(2)	FFP29P	29" Flat Pipe
	(1)	FML235	Solid Adjustable Centre Bracket - Left
	(1)	FMR235	Solid Adjustable Centre Bracket - Right



FHFPH29P (Hardware Kit Included with Mounting Kit)

	(QTY)	
	(2)	Backing Plate
	(2)	Black Clamp
	(6)	Backing Plate Bolts
	(2)	Black Flat End Cap
	(2)	Fine Thread F52 Bolt

Poly Tandem Fender Mounting Kit



FMT50P*

* ADD HD FOR HEAVY DUTY



(QTY)

(4) F32P 32" Long, 4" Off-set Post



(2) FMM360-9



FHT50

(Hardware Kit Included with Mounting Kit)



(QTY)

(6) Black Plastic End Cap



FK50P



FK50PHD

(12) Poly Bracket or * HD for Heavy Duty Adjustable Poly Bracket







(6) Large Hex Head Bolt for Mounting Pipe

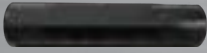

Poly Tandem Fender Mounting Kit

FMFPT29P

	(QTY)		
	(4)	F52P	Post Mount
	(4)	FFP29P	29" Flat Pipe
	(1)	FML235	Solid Adjustable Centre Bracket - Left
	(1)	FMR235	Solid Adjustable Centre Bracket - Right



FHFPT29 (Hardware Kit Included with Mounting Kit)

	(QTY)		
	(4)	Backing Plate	
	(4)	Black Clamp	
	(12)	Backing Plate Bolts	
	(4)	Black Flat End Cap	
	(4)	Fine Thread F52 Bolt	

Poly Single Axle Mounting Kit



FMR50P*

* ADD HD FOR HEAVY DUTY

(QTY)

(4) F32P 32" Long, 4" Off-set Post



FHR50

(Hardware Kit Included with Mounting Kit)

(QTY)

(4) Black Plastic Caps



FK50P



FK50PHD

(8) Poly Bracket or * HD for Heavy Duty Adjustable Poly Bracket



(4) Large Hex Head Bolt for Mounting Pipe



Poly Single Axle Mounting Kit

FMFPR29P

(QTY)

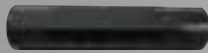

(4) F52P Post Mount



(4) FFP29P 29" Flat Pipe



FHFPR29P

(Hardware Kit Included with Mounting Kit)

(QTY)



(4) Backing Plate



(4) Black Clamp



(4) Fine Thread F52 Bolt



(12) Backing Plate Bolts



(4) Black Flat End Cap

Poly Single Axle Mounting Kit



FMR48P*

* ADD HD FOR HEAVY DUTY

(4) F36P 30" Long, 5" Off-set Post



FHR48

(Hardware Kit Included with Mounting Kit)

(QTY)



(4) Black Plastic Caps



FK50P



FK50PHD

(8) Poly Bracket or * HD for Heavy Duty Adjustable Poly Bracket



(4) Large Hex Head Bolt for Mounting Pipe

Poly Single Axle Mounting Kit

FMR48C*

* ADD HD FOR HEAVY DUTY



(4) F36C 30" Long, 5" Off-set Post



FHR48

(Hardware Kit Included with Mounting Kit)



(QTY)

(4) Black Plastic Caps



FK50P



FK50PHD

(8) Poly Bracket or * HD for Heavy Duty Adjustable Poly Bracket



(4) Large Hex Head Bolt for Mounting Pipe

Poly Half Fender Mounting Kit



FMH48P*

* ADD HD FOR HEAVY DUTY

(QTY)



(2) F36P 30" Long, 5" Off-set Post



(2) FMM360-9



FHH48P

(Hardware Kit Included with Mounting Kit)



(QTY)
(4)

Black Plastic End Cap



FK50P

(8)

Poly Bracket or * HD for Heavy Duty Adjustable Poly Bracket



FK50PHD

(4)

Large Hex Head Bolt for Mounting Pipe





Poly Half Fender Mounting Kit

FMH48C*

* ADD HD FOR HEAVY DUTY

(QTY)



(2) F36C 30" Long, 5" Off-set Post



(2) FMM360-9



FHH48P

(Hardware Kit Included with Mounting Kit)



(QTY)
(4)

Black Plastic End Cap



FK50P

(8)

Poly Bracket or * HD for Heavy Duty Adjustable Poly Bracket



FK50PHD



(4)

Large Hex Head Bolt for Mounting Pipe

Poly Tandem Fender Mounting Kit



FMT48P*

* ADD HD FOR HEAVY DUTY



(QTY)

(4) F36P 30" Long, 5" Off-set Post



(2) FMM360-9



FHT48

(Hardware Kit Included with Mounting Kit)



(QTY)

(6) Black Plastic End Cap



FK50P



FK50PHD

(12) Poly Bracket or * HD for Heavy Duty Adjustable Poly Bracket



(6) Large Hex Head Bolt for Mounting Pipe



Poly Tandem Fender Mounting Kit

FMT48C*

* ADD HD FOR HEAVY DUTY



(QTY)

(4) F36C 30" Long, 5" Off-set Post



(2) FMM360-9



FHT48

(Hardware Kit Included with Mounting Kit)

(QTY)

(6) Black Plastic End Cap



FK50P



FK50PHD

(12) Poly Bracket or * HD for Heavy Duty Adjustable Poly Bracket



(6) Large Hex Head Bolt for Mounting Pipe

3 Rib Tanker Fenders

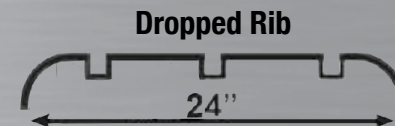

53" Ribbed Single Axle

FR153S

53" Stainless Ribbed Single Axle Fender

16 GA, 49 lbs per set, Fits 43" Tire. *For 46.5", Add **HP** to Part #

FR153A

53" Aluminum Ribbed Single Axle Fender

0.090", 25 lbs per set, Fits 43" Tire. *For 46.5", Add **HP** to Part #



55" Ribbed Single Axle

FR155S

55" Stainless Ribbed Single Axle Fender

16 GA, 51 lbs per set, Fits 43" Tire. *For 46.5", Add **HP** to Part #

FR155A

55" Aluminum Ribbed Single Axle Fender

0.090", 26 lbs per set, Fits 43" Tire. *For 46.5", Add **HP** to Part #



58" Ribbed Single Axle

FR158S

58" Stainless Ribbed Single Axle Fender

16 GA, 54 lbs per set, Fits 43" Tire. *For 46.5", Add **HP** to Part #

FR158A

58" Aluminum Ribbed Single Axle Fender

0.090", 28 lbs per set, Fits 43" Tire. *For 46.5", Add **HP** to Part #





3 Rib Tanker Fenders

60" Ribbed Single Axle

FR160S

60" Stainless Ribbed Single Axle Fender
16 GA, 56 lbs per set, Fits 43" Tire. *For 46.5", Add  to Part #

FR160A

60" Aluminum Ribbed Single Axle Fender
0.090", 29 lbs per set, Fits 43" Tire. *For 46.5", Add  to Part #



66" Ribbed Single Axle

FR166S

66" Stainless Ribbed Single Axle Fender
16 GA, 61 lbs per set, Fits 43" Tire. *For 46.5", Add  to Part #

FR166A

66" Aluminum Ribbed Single Axle Fender
0.090", 32 lbs per set, Fits 43" Tire. *For 46.5", Add  to Part #



108" Ribbed Tandem

FR10854S

108" Stainless Ribbed Tandem Fender
16 GA, 99 lbs per set, Fits 43" Tire. *For 46.5", Add  to Part #

FR10854A

108" Aluminum Ribbed Tandem Fender
0.090", 52 lbs per set, Fits 43" Tire. *For 46.5", Add  to Part #



3 Rib Tanker Half Fenders

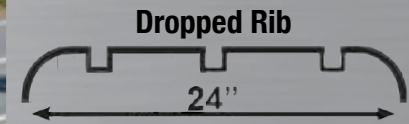

125" Ribbed Half Fender

FR125S

125" Stainless Ribbed Half Fender
16 GA, 116 lbs per Set, Fits 43" or 46.5" Tire

FR125A

125" Aluminum Ribbed Half Fender
0.090", 60 lbs per Set, Fits 43" or 46.5" Tire



144" Ribbed Half Fender

FR144S

144" Stainless Ribbed Half Fender
16 GA, 134 lbs per Set, Fits 43" or 46.5" Tire

FR144A

144" Aluminum Ribbed Half Fender
0.090", 69 lbs per Set, Fits 43" or 46.5" Tire



150" Ribbed Half Fender

FR150S

150" Stainless Ribbed Half Fender
16 GA, 144 lbs per Set, Fits 43" or 46.5" Tire

FR150A

150" Aluminum Ribbed Half Fender
0.090", 74 lbs per Set, Fits 43" or 46.5" Tire

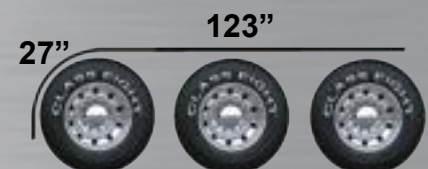



Poly Tanker Fenders



Poly Half Fender 105"

FX105P#
105" Black Poly Fender
50 lbs per set



Poly Extension 24"

FX24P
24" Black Poly Fender Extension
6 lbs per set

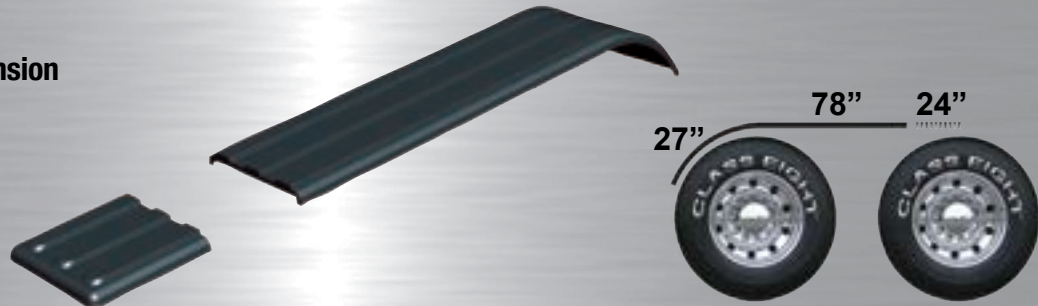

Poly Extension 34"

FX34P
34" Black Poly Fender Extension
11 lbs per set



Poly Locking Tool Box

TB700
Black Poly Locking Tool Box

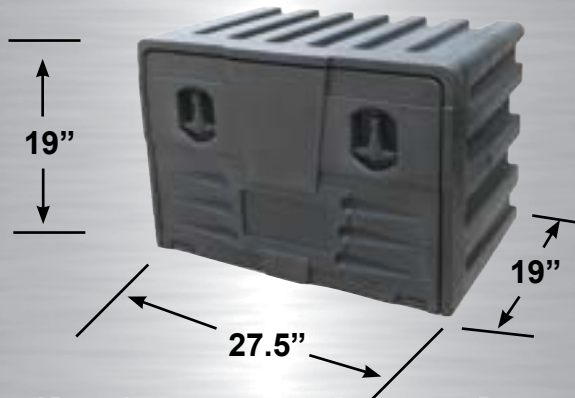

Fender Mounting Accesories

FQP29S	29" Quarter Fender Pipe with Holes Thin Wall 18 GA	
F29S	29" Stainless Steel Side Mount Pipe with Holes 14GA	
F38P	38" Powder Coated 9" Off-set Post	
F32P	32" Powder Coated 4" Off-set Post	
FMR230	Adjustable Centre Bracket Support Bracket - Right Side	
FML230	Adjustable Centre Bracket Support Bracket - Left Side	
FM230	Solid Centre Bracket	
FML230FL	Mounting Bracket Left	
FMR230FR	Mounting Bracket Right	
FM235LH	Mounting Bracket Left	
FM235RH	Mounting Bracket Right	
FML235	Solid Adjustable Centre Bracket - Left Side	
FMR235	Solid Adjustable Centre Bracket - Right Side	
*Rubber Strip and Bolts Included in All Above		
FFP29P-Kit	29" Flat Pipe Kit, with Post, Clamp, Backing Plate & Bolts	
FM360-9	9" Off-set Centre Bracket	
FM360-4	4" Off-set Centre Bracket	
FMM360-4	4" Off-set Rotating 360° Centre Bracket	
FMM360-9	9" Off-set Rotating 360° Centre Bracket	



Fender Mounting Accessories

FCPNH94*

94" Cross Pipe No Holes

*ADD C FOR CHROME, S FOR STAINLESS OR Z FOR ZINC



FCP94*

94" Cross Pipe with Holes

*ADD C FOR CHROME, S FOR STAINLESS OR Z FOR ZINC



FFBL30*

30" Left 4-Bolt Side Mount with Holes



FFBR30*

30" Right 4-Bolt Side Mount with Holes

ADD C FOR CHROME OR Z FOR ZINC



FFBNH30*

30" Side Mount 4-Bolt Side Mount No Holes

ADD C FOR CHROME OR Z FOR ZINC



FSB30C

Chrome 30" Side Mount Single Bolt with Holes



FSB30Z

Zinc 30" Side Mount Single Bolt with Holes



FSB30P

Painted 30" Side Mount Single Bolt with Holes



FSBNH30C

Chrome 30" Side Mount No Holes



FSBNH30Z

Zinc 30" Side Mount No Holes



FSBNH30P

Painted 30" Side Mount No Holes



FB2S

Small Fender Brace (Round)



FTF

Fender Top Flap (Rubber)



FTF-Logo

Logo Fender Top Flap (Plastic)



Fender Mounting Accesories



FML29PBS 29" Peterbilt Stainless Steel Bracket - Left

FMR29PBS 29" Peterbilt Stainless Steel Bracket - Right



F36C Chrome Offset Bracket

F36P Painted Offset Bracket



F2125S Stainless Steel Clamp



CEC-1 1 7/8" Chrome Plastic End Cap

CEC-2 2" Chrome Plastic End Cap

BEC-1 1 7/8" Black Plastic End Cap

BEC-2 2" Black Plastic End Cap



FWBS "W" Bracket for 3 Bolt Mount

FWBS6 "W" Bracket for U Bolt Mount



FRS Universal Rubber Strip for Centre Mount



F200SB 14 GA Stainless Steel Triangle Side Mount With Bolts

F200SBHD 12 GA 304 Mirror Finish Stainless Steel Triangle Side Mount with Bolts





Fender Mounting Accesories

F52

Post Mount 3/4" Fine Thread



F52U

Post Mount 5/8" Hole Unthreaded



F52-360

360° Adjustable Post Mount



F52PBL

Peterbilt Post Mount - Left

F52PBR

Peterbilt Post Mount - Right



F123

U-Bolt with Rubber



FK50P

Light Duty (1 7/8" to 2") Poly Bracket - 1 Unit



FK50PHD

Heavy Duty Adjustable (1 7/8" to 2") Poly Bracket - 1 Unit



Half Fender Mounting Kit



FMH200S*

* ADD HD FOR HEAVY DUTY



(QTY)



(2) F200SB 14 GA Triangle Side Mounts
12 GA Triangle Side Mount included in HD



(2) F52 Post Mount Threaded
or

(2) F52U Post Mount Unthreaded



6 Centre Bracket Options - One Price

FMH200S-1



QTY: 2
FML230 & FMR230
Adjustable Centre Bracket
Left & Right 8 - 12" Height
All necessary hardware included

FMH200S-2



QTY: 2
FMM360-9 (4" Version available)
360° Swivel Pad Mount Bracket
Universal Fit 9" Off set
All necessary hardware included

FMH200S-3

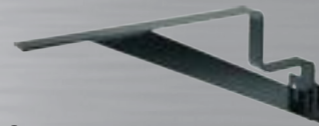

QTY: 2
FM230
Solid Centre Bracket
Universal Fit 12 3/4" Height
All necessary hardware included

FMH200S-4



QTY: 2
FML230FL & FMR230FL
Height 12"
Left & Right Bracket
All necessary hardware included

FMH200S-5



QTY: 2
FM235LH & FM235RH
7 1/2" Height
Left & Right Bracket
All necessary hardware included

FMH200S-6



QTY: 2
FM360-9 (4" Version available)
360° Swivel Mount Bracket
Universal Fit 9" Off set
All necessary hardware included

FHH200

(Hardware Kit Included with Mounting Kit)

(QTY)

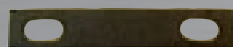

(6) Backing Plate



(12) Triangle Bolt & Washer



(2) SS Clamp for Triangle Bolt



(2) Fine Thread F52 Bolt

905 760 8103





www.class8mfg.com

65



Half Fender Mounting Kits

FMBH29S

	(2)	F29S	29" Stainless Steel Tube	
	(2)	F52	Post Mount Threaded or	
	(2)	F52U	Post Mount Unthreaded	

6 Centre Bracket Options - One Price

FMBH29S-1



QTY: 2
FML230 & FMR230
Adjustable Centre Bracket
Left & Right 8 - 12" Height
All necessary hardware included

FMBH29S-2



QTY: 2
FMM360-9 (4" Version available)
360° Swivel Pad Mount Bracket
Universal Fit 9" Off set
All necessary hardware included

FMBH29S-3



QTY: 2
FM230
Solid Centre Bracket
Universal Fit 12 3/4" Height
All necessary hardware included

FMBH29S-4



QTY: 2
FML230 & FMR230
Adjustable Centre Bracket
Left & Right Bracket
All necessary hardware included

FMBH29S-5



QTY: 2
FM235LH & FM235RH
7 1/2" Height
Left & Right Bracket
All necessary hardware included

FMBH29S-6



QTY: 2
FM360-9 (4" Version available)
360° Swivel Mount Bracket
Universal Fit 9" Off set
All necessary hardware included

FHFBH29 (Hardware Kit Included with Mounting Kit)

	(2)	SS Clamp for Post Mount Tube		(2)	W Bracket SS - 3 Hole
	(2)	Fine Thread F52 Bolt		(2)	Chrome Plastic End Cap
	(6)	Brace		(6)	Cap Bolt, Lock Nut & Washer
	(6)	Brace Bolt, Nut & Washer			

Half Fender Mounting Kits



FMCBH94* (*Add C to the End of the Part # for Chrome, S for Stainless or Z for Zinc)

(QTY)

(1) FCP94* 94" Cross Pipe with Holes



6 Centre Bracket Options - One Price

FMCBH94*-1



QTY: 2
FML230 & FMR230
Adjustable Centre Bracket
Left & Right 8 - 12" Height
All necessary hardware included

FMCBH94*-2



QTY: 2
FMM360-9 (4" Version available)
360° Swivel Pad Mount Bracket
Universal Fit 9" Off set
All necessary hardware included

FMCBH94*-3

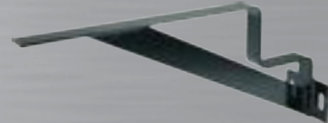

QTY: 2
FM230
Solid Centre Bracket
Universal Fit 12 3/4" Height
All necessary hardware included

FMCBH94*-4



QTY: 2
FML230FL & FMR230FL
Height 12"
Left & Right Bracket
All necessary hardware included

FMCBH94*-5



QTY: 2
FM235LH & FM235RH
7 1/2" Height
Left & Right Bracket
All necessary hardware included

FMCBH94*-6



QTY: 2
FM360-9 (4" Version available)
360° Swivel Mount Bracket
Universal Fit 9" Off set
All necessary hardware included

FHCBH94 (Hardware Kit Included with Mounting Kit)

(QTY)



(6) Brace



(2) W Bracket SS - 3 Hole



(6) Braced Bolt, Nut & Washer



(2) Chrome Plastic End Cap



(2) Cross Pipe Hold Down (Frame Bracket)



(6) Cap Bolt, Lock Nut & Washer

905 760 8103

www.class8mfg.com

67



Half Fender Mounting Kits

FMCH94*U (*Add C for Chrome, S for Stainless or Z for Zinc Where the * is in the Part #)

(QTY)

(1) FCPNH94* 94" Cross Pipe No Holes



6 Centre Bracket Options - One Price

FMCH94*U-1



QTY: 2
FML230 & FMR230
Adjustable Centre Bracket
Left & Right 8 - 12" Height
All necessary hardware included

FMCH94*U-2



QTY: 2
FMM360-9 (4" Version available)
360° Swivel Pad Mount Bracket
Universal Fit 9" Off set
All necessary hardware included

FMCH94*U-3



QTY: 2
FM230
Solid Centre Bracket
Universal Fit 12 3/4" Height
All necessary hardware included

FMCH94*U-4



QTY: 2
FML230FL & FMR230FL
Height 12"
Left & Right Bracket
All necessary hardware included

FMCH94*U-5



QTY: 2
FM235LH & FM235RH
7 1/2" Height
Left & Right Bracket
All necessary hardware included

FMCH94*U-6



QTY: 2
FM360-9 (4" Version available)
360° Swivel Mount Bracket
Universal Fit 9" Off set
All necessary hardware included

FHCH94U (Hardware Kit Included with Mounting Kit)

(QTY)



(2) W Bracket SS - 6 Hole



(2) Chrome Plastic End Cap



(6) Small U-Bolt Kit with Rubber, Nuts, Washers & Back Plate



(2) Cross Pipe hold Down (Frame Bracket)

Half Fender Mounting Kits



FMFBBH30* (*Add C to the End of the Part # for Chrome or Z for Zinc)

(QTY)

(1) **FFBL30*** 30" 4-Bolt Pipe - Left



(1) **FFBR30*** 30" 4-Bolt Pipe - Right



6 Centre Bracket Options - One Price

FMFBBH30*-1



QTY: 2
FML230 & FMR230
 Adjustable Centre Bracket
 Left & Right 8 - 12" Height
 All necessary hardware included

FMFBBH30*-2



QTY: 2
FMM360-9 (4" Version available)
 360° Swivel Pad Mount Bracket
 Universal Fit 9" Off set
 All necessary hardware included

FMFBBH30*-3



QTY: 2
FM230
 Solid Centre Bracket
 Universal Fit 12 3/4" Height
 All necessary hardware included

FMFBBH30*-4



QTY: 2
FML230FL & FMR230FL
 Height 12"
 Left & Right Bracket
 All necessary hardware included

FMFBBH30*-5



QTY: 2
FM235LH & FM235RH
 7 1/2" Height
 Left & Right Bracket
 All necessary hardware included

FMFBBH30*-6



QTY: 2
FM360-9 (4" Version available)
 360° Swivel Mount Bracket
 Universal Fit 9" Off set
 All necessary hardware included

FHFBBH30

(Hardware Kit Included with Mounting Kit)

(QTY)



(6) **Brace**



(2) **W Bracket SS - 3 Hole**



(8) **Four Bolt Side Mount Nut & Washer**



(2) **Chrome Plastic End Cap**



(6) **Brace Bolt, Nut & Washer**



(6) **Cap Bolt, Lock Nut & Washer**

905 760 8103

www.class8mfg.com

69



Half Fender Mounting Kits

FMFBH30*U (Add C for Chrome or Z for Zinc Where the * is in the Part #)

(QTY)

(2) FFBNH30*

30" 4-Bolt Pipe No Holes



6 Centre Bracket Options - One Price

FMFBH30*U-1



QTY: 2
FML230 & FMR230
Adjustable Centre Bracket
Left & Right 8 - 12" Height
All necessary hardware included

FMFBH30*U-2



QTY: 2
FMM360-9 (4" Version available)
360° Swivel Pad Mount Bracket
Universal Fit 9" Off set
All necessary hardware included

FMFBH30*U-3

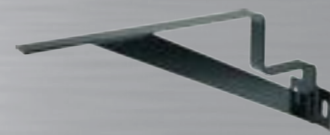

QTY: 2
FM230
Solid Centre Bracket
Universal Fit 12 3/4" Height
All necessary hardware included

FMFBH30*U-4



QTY: 2
FML230FL & FMR230FL
Height 12"
Left & Right Bracket
All necessary hardware included

FMFBH30*U-5



QTY: 2
FM235LH & FM235RH
7 1/2" Height
Left & Right Bracket
All necessary hardware included

FMFBH30*U-6



QTY: 2
FM360-9 (4" Version available)
360° Swivel Mount Bracket
Universal Fit 9" Off set
All necessary hardware included

FHFBH30U

(Hardware Kit Included with Mounting Kit)

(QTY)



(2) W Bracket SS - 6 Hole



(2) Chrome Plastic End Caps



(6) Small U-Bolt Kit with Rubber, Nuts, Washers & Back Plate



(8) Four Bolt Side Mount Nut & Washer

Half Fender Mounting Kits



FMSBBH30* (*Add C to the End of the Part # for Chrome or Z for Zinc)

(QTY)

(2) FSB30* 30" Single Pipe with Holes



6 Centre Bracket Options - One Price

FMSBBH30*-1



QTY: 2
FML230 & FMR230
Adjustable Centre Bracket
Left & Right 8 - 12' Height
All necessary hardware included

FMSBBH30*-2



QTY: 2
FMM360-9 (4" Version available)
360° Swivel Pad Mount Bracket
Universal Fit 9" Off set
All necessary hardware included

FMSBBH30*-3



QTY: 2
FM230
Solid Centre Bracket
Universal Fit 12 3/4" Height
All necessary hardware included

FMSBBH30*-4



QTY: 2
FML230FL & FMR230FL
Height 12"
Left & Right Bracket
All necessary hardware included

FMSBBH30*-5



QTY: 2
FM235LH & FM235RH
7 1/2" Height
Left & Right Bracket
All necessary hardware included

FMSBBH30*-6



QTY: 2
FM360-9 (4" Version available)
360° Swivel Mount Bracket
Universal Fit 9" Off set
All necessary hardware included

FHSBBH30 (Hardware Kit Included with Mounting Kit)

(QTY)



(6) Cap Bolt, Lock Nut & Washer



(2) W Bracket SS - 3 Hole



(6) Brace



(2) Chrome Plastic End Cap



(6) Brace Bolt, Nut & Washer



(2) Large Hex Head Bolt for Mounting Pipe

905 760 8103

www.class8mfg.com

71



Half Fender Mounting Kits

FMSBH30*U (Add C for Chrome or Z for Zinc Where the * is in the Part #)

(QTY)

(2) **FSBNH30*** 30" Side Mount Single Bolt - No Holes



6 Centre Bracket Options - One Price

FMSBH30*U-1



QTY: 2
FML230 & FMR230
Adjustable Centre Bracket
Left & Right 8 - 12" Height
All necessary hardware included

FMSBH30*U-2



QTY: 2
FMM360-9 (4" Version available)
360° Swivel Pad Mount Bracket
Universal Fit 9" Off set
All necessary hardware included

FMSBH30*U-3

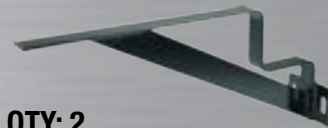

QTY: 2
FM230
Solid Centre Bracket
Universal Fit 12 3/4" Height
All necessary hardware included

FMSBH30*U-4



QTY: 2
FML230FL & FMR230FL
Height 12"
Left & Right Bracket
All necessary hardware included

FMSBH30*U-5



QTY: 2
FM235LH & FM235RH
7 1/2" Height
Left & Right Bracket
All necessary hardware included

FMSBH30*U-6



QTY: 2
FM360-9 (4" Version available)
360° Swivel Mount Bracket
Universal Fit 9" Off set
All necessary hardware included

FHSBH30U (Hardware Kit Included with Mounting Kit)

(QTY)



(2) **W Bracket SS - 6 Hole**



(2) **Chrome Plastic End Cap**



(2) **Large Hex Head Bolt for Mounting Pipe**



(6) **Small U-Bolt Kit with Rubber, Nuts, Washers & Back Plate**



Tandem Fender Mounting Kits



FMT200S*

* Add HD for Heavy Duty



- | | | | |
|-------|--------|---|--|
| (QTY) | | | |
| (4) | F200SB | 14 GA Triangle Side Mounts | |
| | | 12 GA Triangle Side Mount included in HD | |
| | |  | |
| (4) | F52 | Post Mount Threaded | |
| | | or | |
| (4) | F52U | Post Mount Unthreaded | |
| | |  | |

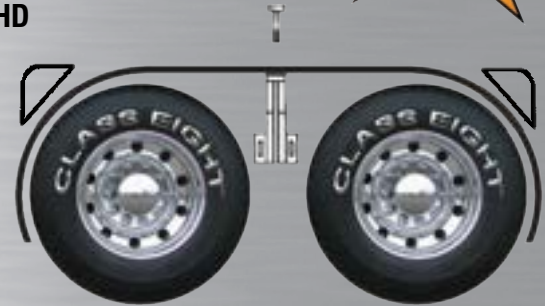

6 Centre Bracket Options - One Price

FMT200S*-1



QTY: 2
FML230 & FMR230
Adjustable Centre Bracket
Left & Right 8 - 12" Height
All necessary hardware included

FMT200S*-2



QTY: 2
FMM360-9 (4" Version available)
360° Swivel Pad Mount Bracket
Universal Fit 9" Off set
All necessary hardware included

FMT200S*-3

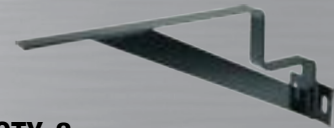

QTY: 2
FM230
Solid Centre Bracket
Universal Fit 12 3/4" Height
All necessary hardware included

FMT200S*-4



QTY: 2
FML230FL & FMR230FL
Height 12"
Left & Right Bracket
All necessary hardware included

FMT200S*-5



QTY: 2
FM235LH & FM235RH
7 1/2" Height
Left & Right Bracket
All necessary hardware included

FMT200S*-6



QTY: 2
FM360-9 (4" Version available)
360° Swivel Mount Bracket
Universal Fit 9" Off set
All necessary hardware included

FHT200 (Hardware Kit Included with Mounting Kit)

- | | | |
|-------|---|----------------------------|
| (QTY) | | |
| (12) |  | Backing Plate |
| (24) |  | Triangle Bolt & Washer |
| (4) |  | SS Clamp for Triangle Bolt |
| (4) |  | Fine Thread F52 Bolt |

905 760 8103

www.class8mfg.com

73

Tandem Fender Mounting Kits

FMFBBT30* (*Add C to the End of the Part # for Chrome or Z for Zinc)

(QTY)

(2) **FFBL30*** 30" 4-Bolt Pipe - Left



(2) **FFBR30*** 30" 4-Bolt Pipe - Right

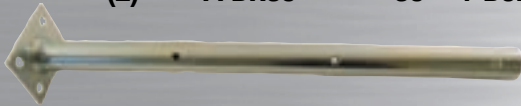

6 Centre Bracket Options - One Price

FMFBBT30*-1



QTY: 2
FML230 & FMR230
 Adjustable Centre Bracket
 Left & Right 8 - 12" Height
 All necessary hardware included

FMFBBT30*-2



QTY: 2
FMM360-9 (4" Version available)
 360° Swivel Pad Mount Bracket
 Universal Fit 9" Off set
 All necessary hardware included

FMFBBT30*-3

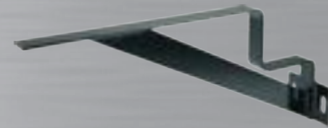

QTY: 2
FM230
 Solid Centre Bracket
 Universal Fit 12 3/4" Height
 All necessary hardware included

FMFBBT30*-4



QTY: 2
FML230FL & FMR230FL
 Height 12"
 Left & Right Bracket
 All necessary hardware included

FMFBBT30*-5



QTY: 2
FM235LH & FM235RH
 7 1/2" Height
 Left & Right Bracket
 All necessary hardware included

FMFBBT30*-6



QTY: 2
FM360-9 (4" Version available)
 360° Swivel Mount Bracket
 Universal Fit 9" Off set
 All necessary hardware included

FHFBBT30 (Hardware Kit Included with Mounting Kit)

(QTY)



(12) **Cap Bolt, Lock Nut & Washer**



(4) **W Bracket SS - 3 Hole**



(6) **Brace**



(4) **Chrome Plastic End Cap**



(16) **Four Bolt Side Mount Nut&Washer**



(6) **Brace Bolt, Nut & Washer**

Tandem Fender Mounting Kits



FMSBBT30* (*Add C to the End of the Part # for Chrome or Z for Zinc)

(QTY)

(4) FSB30* 30" Single Bolt Pipe with Holes

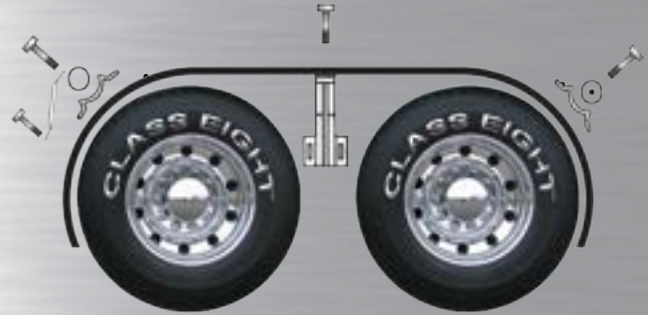

6 Centre Bracket Options - One Price

FMSBBT30*-1



QTY: 2
FML230 & FMR230
Adjustable Centre Bracket
Left & Right 8 - 12" Height
All necessary hardware included

FMSBBT30*-2



QTY: 2
FMM360-9 (4" Version available)
360° Swivel Pad Mount Bracket
Universal Fit 9" Off set
All necessary hardware included

FMSBBT30*-3

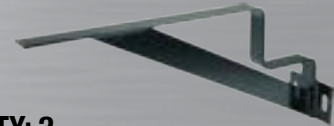

QTY: 2
FM230
Solid Centre Bracket
Universal Fit 12 3/4" Height
All necessary hardware included

FMSBBT30*-4



QTY: 2
FML230FL & FMR230FL
Height 12"
Left & Right Bracket
All necessary hardware included

FMSBBT30*-5



QTY: 2
FM235LH & FM235RH
7 1/2" Height
Left & Right Bracket
All necessary hardware included

FMSBBT30*-6



QTY: 2
FM360-9 (4" Version available)
360° Swivel Mount Bracket
Universal Fit 9" Off set
All necessary hardware included

FHSBBT30 (Hardware Kit Included with Mounting Kit)

(QTY)



(12) Cap Bolt, Lock Nut & Washer



(4) W Bracket SS - 3 Hole



(6) Brace



(4) Chrome Plastic End Cap





(6) Brace Bolt, Nut & Washer



(4) Large Hex Head Bolt for Mounting Pipe

Tandem Fender Mounting Kits

FMBT29S

- (QTY)
 (4) F29S 29" Stainless Steel Tube

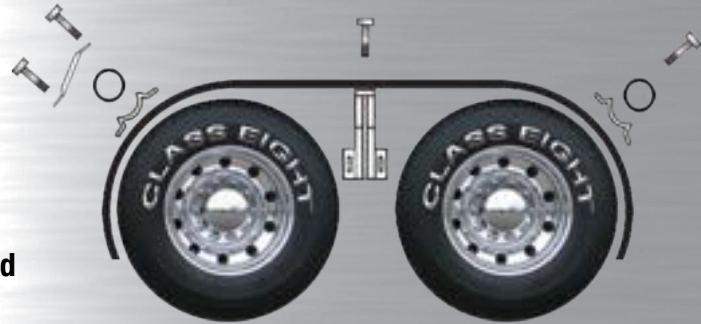
 (4) F52 Post Mount Threaded
 or
 (4) F52U Post Mount Unthreaded



6 Centre Bracket Options - One Price

FMBT29S-1

- 
- QTY: 2
 FML230 & FMR230
 Adjustable Centre Bracket
 Left & Right 8 - 12" Height
 All necessary hardware included

FMBT29S-2

- 
- QTY: 2
 FMM360-9 (4" Version available)
 360° Swivel Pad Mount Bracket
 Universal Fit 9" Off set
 All necessary hardware included

FMBT29S-3

- 
- QTY: 2
 FM230
 Solid Centre Bracket
 Universal Fit 12 3/4" Height
 All necessary hardware included

FMBT29S*-4

- 
- QTY: 2
 FML230FL & FMR230FL
 Height 12"
 Left & Right Bracket
 All necessary hardware included

FMBT29S*-5

- 
- QTY: 2
 FM235LH & FM235RH
 7 1/2" Height
 Left & Right Bracket
 All necessary hardware included

FMBT29S*-6

- 
- QTY: 2
 FM360-9 (4" Version available)
 360° Swivel Mount Bracket
 Universal Fit 9" Off set
 All necessary hardware included

FHBT29 (Hardware Kit Included with Mounting Kit)

- (QTY)
 (4) Fine Thread F52 Bolt

 (4) SS Clamp for Post Mount Tube

 (6) Brace

 (4) W Bracket SS - 3 Hole

 (6) Brace Bolt, Nut & Washer

 (4) Chrome Plastic End Cap

 (12) Cap Bolt, Lock Nut & Washer

Tandem Fender Mounting Kits



FMCFBBT94* (*Add C to the End of the Part # for Chrome or Z for Zinc)

(QTY)

(1) FCP94* 94" Cross Pipe with Holes



(1) FFBR30* 4-Bolt Pipe Right



(1) FFBL30* 4-Bolt Pipe Left



6 Centre Bracket Options - One Price

FMCFBBT94*-1



QTY: 2
FML230 & FMR230
Adjustable Centre Bracket
Left & Right 8 - 12" Height
All necessary hardware included

FMCFBBT94*-2



QTY: 2
FMM360-9 (4" Version available)
360° Swivel Pad Mount Bracket
Universal Fit 9" Off set
All necessary hardware included

FMCFBBT94*-3

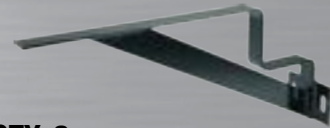

QTY: 2
FM230
Solid Centre Bracket
Universal Fit 12 3/4" Height
All necessary hardware included

FMCFBBT94*-4



QTY: 2
FML230FL & FMR230FL
Height 12"
Left & Right Bracket
All necessary hardware included

FMCFBBT94*-5



QTY: 2
FM235LH & FM235RH
7 1/2" Height
Left & Right Bracket
All necessary hardware included

FMCFBBT94*-6



QTY: 2
FM360-9 (4" Version available)
360° Swivel Mount Bracket
Universal Fit 9" Off set
All necessary hardware included

FHCFBBT94 (Hardware Kit Included with Mounting Kit)

(QTY)



(6) Brace



(4) W Bracket SS - 3 Hole



(6) Brace Bolt, Nut & Washer



(2) 1 7/8" Chrome Plastic End Cap



(2) Cross Pipe Hold Down
(Frame Bracket)



(2) 2" Chrome Plastic End Cap



(8) Four Bolt Side Mount Nut
& Washer



(12) Cap Bolt, Lock Nut & Washer

905 760 8103

www.class8mfg.com

77

Tandem Fender Mounting Kits

FMCFBT94*U (*Add C for Chrome or Z for Zinc Where the * is in the Part #)

(QTY)

(1) FCPNH94* 94" Cross Pipe with No Holes



(2) FFBNH30* 4 Bolt Pipe with No holes

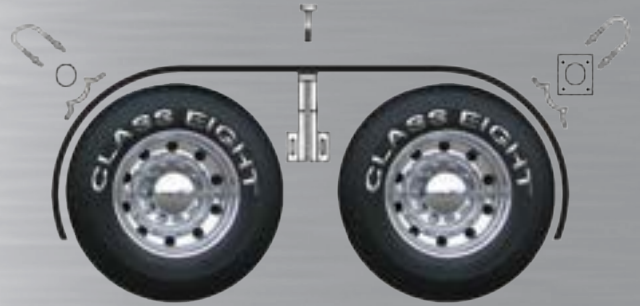

6 Centre Bracket Options - One Price

FMCFBT94*U-1



QTY: 2
FML230 & FMR230
Adjustable Centre Bracket
Left & Right 8 - 12" Height
All necessary hardware included

FMCFBT94*U-2



QTY: 2
FMM360-9 (4" Version available)
360° Swivel Pad Mount Bracket
Universal Fit 9" Off set
All necessary hardware included

FMCFBT94*U-3

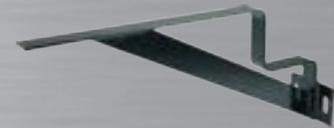

QTY: 2
FM230
Solid Centre Bracket
Universal Fit 12 3/4" Height
All necessary hardware included

FMCFBT94*U-4



QTY: 2
FML230FL & FMR230FL
Height 12"
Left & Right Bracket
All necessary hardware included

FMCFBT94*U-5



QTY: 2
FM235LH & FM235RH
7 1/2" Height
Left & Right Bracket
All necessary hardware included

FMCFBT94*U-6



QTY: 2
FM360-9 (4" Version available)
360° Swivel Mount Bracket
Universal Fit 9" Off set
All necessary hardware included

FHCFBT94U (Hardware Kit included with Mounting Kit)

(QTY)



(8) Four Bolt Side Mount
Nut & Washer



(4) W Bracket SS - 3 Hole



(12) Small U-Bolt Kit with Rubber,
Nuts, Washers & Back Plate



(2) 1 7/8" Chrome Plastic End Cap



(2) Cross Pipe Hold Down
(Frame Bracket)



(2) 2" Chrome Plastic End Cap

Tandem Fender Mounting Kits



FMCSBBT94* (*Add C to the End of the Part # for Chrome or Z for Zinc)

- (QTY)
- (1) **FCP94*** 94" Cross Pipe with Holes
- (2) **FSB30*** 30" Single Bolt Pipe with Holes

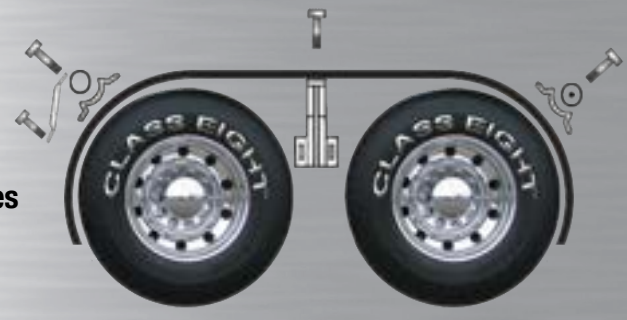

6 Centre Bracket Options - One Price

FMCSBBT94*-1



QTY: 2
FML230 & FMR230
 Adjustable Centre Bracket
 Left & Right 8 - 12" Height
 All necessary hardware included

FMCSBBT94*-2



QTY: 2
FMM360-9 (4" Version available)
 360° Swivel Pad Mount Bracket
 Universal Fit 9" Off set
 All necessary hardware included

FMCSBBT94*-3

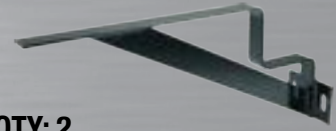

QTY: 2
FM230
 Solid Centre Bracket
 Universal Fit 12 3/4" Height
 All necessary hardware included

FMCSBBT94*-4



QTY: 2
FML230FL & FMR230FL
 Height 12"
 Left & Right Bracket
 All necessary hardware included

FMCSBBT94*-5



QTY: 2
FM235LH & FM235RH
 7 1/2" Height
 Left & Right Bracket
 All necessary hardware included

FMCSBBT94*-6



QTY: 2
FM360-9 (4" Version available)
 360° Swivel Mount Bracket
 Universal Fit 9" Off set
 All necessary hardware included

FHCSBBT94 (Hardware Kit Included with Mounting Kit)

- (QTY)
- (6) **Brace**
- (6) **Brace Bolt, Nut & Washer**
- (2) **Cross Pipe Hold Down (Frame Bracket)**
- (8) **Four Bolt Side Mount Nut & Washer**
- (4) **W Bracket SS - 3 Hole**
- (2) **1 7/8" Chrome Plastic End Cap**
- (2) **2" Chrome Plastic End Cap**
- (12) **Cap Bolt, Lock Nut & Washer**

Tandem Fender Mounting Kits

FMCSBT94*U (Add C for Chrome or Z for Zinc Where the * is in the Part #)

(QTY)
(1) FCPNH94* 94" Cross Pipe No Holes

(2) FSBNH30* 30" Single Bolt Pipe No Holes



6 Centre Bracket Options - One Price

FMCSBT94*U-1



QTY: 2
FML230 & FMR230
Adjustable Centre Bracket
Left & Right 8 - 12" Height
All necessary hardware included

FMCSBT94*U-2



QTY: 2
FMM360-9 (4" Version available)
360° Swivel Pad Mount Bracket
Universal Fit 9" Off set
All necessary hardware included

FMCSBT94*U-3

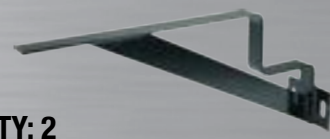

QTY: 2
FM230
Solid Centre Bracket
Universal Fit 12 3/4" Height
All necessary hardware included

FMCSBT94*U-4



QTY: 2
FML230FL & FMR230FL
Height 12"
Left & Right Bracket
All necessary hardware included

FMCSBT94*U-5



QTY: 2
FM235LH & FM235RH
7 1/2" Height
Left & Right Bracket
All necessary hardware included

FMCSBT94*U-6



QTY: 2
FM360-9 (4" Version available)
360° Swivel Mount Bracket
Universal Fit 9" Off set
All necessary hardware included

FHCSBT94U (Hardware Kit Included with Mounting Kit)

(QTY)



(4) W Bracket SS - 3 Hole



(2) Large Hex Head Bolt for Mounting Pipe



(2) 1 7/8" Chrome Plastic End Cap



(2) 2" Chrome Plastic End Cap



(2) Cross Pipe Hold Down (Frame Bracket)



(12) Small U-Bolt Kit with Rubber, Nuts Washers & Back Plate

Tandem Fender Mounting Kits

FMFBT30*U (Add C for Chrome or Z for Zinc Where the * is in the Part #)

(QTY)

(4) FFBNH30* 30" Pipe 4-Bolt No Holes

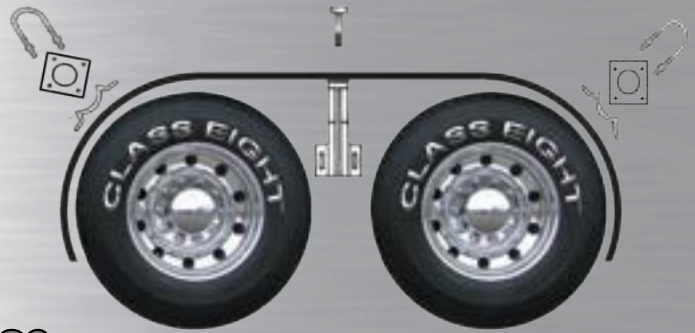

6 Centre Bracket Options - One Price

FMFBT30*U-1



QTY: 2
FML230 & FMR230
Adjustable Centre Bracket
Left & Right 8 - 12" Height
All necessary hardware included

FMFBT30*U-2



QTY: 2
FMM360-9 (4" Version available)
360° Swivel Pad Mount Bracket
Universal Fit 9" Off set
All necessary hardware included

FMFBT30*U-3



QTY: 2
FM230
Solid Centre Bracket
Universal Fit 12 3/4" Height
All necessary hardware included

FMFBT30*U-4



QTY: 2
FML230FL & FMR230FL
Height 12"
Left & Right Bracket
All necessary hardware included

FMFBT30*U-5



QTY: 2
FM235LH & FM235RH
7 1/2" Height
Left & Right Bracket
All necessary hardware included

FMFBT30*U-6



QTY: 2
FM360-9 (4" Version available)
360° Swivel Mount Bracket
Universal Fit 9" Off set
All necessary hardware included

FHFBT30U (Hardware Kit Included with Mounting Kit)

(QTY)



(4) W Bracket SS - 6 Hole



(4) Chrome Plastic End Cap



(16) Four Bolt Side Mount Nut & Washer



(12) Small U-Bolt Kit with Rubber, Nuts, Washers & Back Plate

905 760 8103

www.class8mfg.com

81

Tandem Fender Mounting Kits

FMSBT30*U (Add C for Chrome or Z for Zinc Where the * is in the Part #)

(QTY)

(4) **FSBNH30*** 30" Pipe No Holes



6 Centre Bracket Options - One Price

FMSBT30*U-1



QTY: 2
FML230 & FMR230
 Adjustable Centre Bracket
 Left & Right 8 - 12" Height
 All necessary hardware included

FMSBT30*U-2



QTY: 2
FMM360-9 (4" Version available)
 360° Swivel Pad Mount Bracket
 Universal Fit 9" Off set
 All necessary hardware included

FMSBT30*U-3



QTY: 2
FM230
 Solid Centre Bracket
 Universal Fit 12 3/4" Height
 All necessary hardware included

FMSBT30*U-4



QTY: 2
FML230FL & FMR230FL
 Height 12"
 Left & Right Bracket
 All necessary hardware included

FMSBT30*U-5



QTY: 2
FM235LH & FM235RH
 7 1/2" Height
 Left & Right Bracket
 All necessary hardware included

FMSBT30*U-6



QTY: 2
FM360-9 (4" Version available)
 360° Swivel Mount Bracket
 Universal Fit 9" Off set
 All necessary hardware included

FHSBT30U (Hardware Kit Included with Mounting Kit)

(QTY)



(4) **W Bracket SS - 6 Hole**



(4) **Chrome Plastic End Cap**



(12) **Small U-Bolt Kit with Rubber, Nuts, Washers & Back Plate**



(4) **Large Hex Head Bolt for Mounting Pipe**

Single Axle Mounting Kits



FMR200S* * Add HD for Heavy Duty



(QTY)

- (4) F200SB 14 GA Triangle Side Mount
12 GA Triangle Side Mount included in HD



- (4) F52 Post Mount Threaded
or
- (4) F52U Post Mount Unthreaded



FHR200S (Hardware Kit Included with Mounting Kit)

(QTY)

- (4) SS Clamp for Triangle Mount



- (24) Triangle Mount Bolt & Washer



- (4) Fine Thread F52 Bolt



- (12) Backing Plate





Single Axle Mounting Kits

FMFBBR30* (*Add C to the End of the Part # for Chrome or Z for Zinc)

(QTY)



(2) **FFBL30*** 30" 4-Bolt Pipe with Holes - Left



(2) **FFBR30*** 30" 4-Bolt Pipe with Holes - Right



FHFBBR30 (Hardware Kit Included with Mounting Kit)

(QTY)



(4) **W Bracket SS - 3 Hole**



(4) **1 7/8" Chrome Plastic End Cap**



(12) **2 1/2" Cap Bolt Lock Nut & Washer**



(16) **Four Bolt Side Mount Nut & Washer**



(12) **Brace Bolt, Nut & Washer**



(12) **Brace**

Single Axle Mounting Kits



FMFBR30*U (Add C for Chrome or Z for Zinc Where the * is in the Part #)

(QTY)

(4) **FFBNH30*** 30" 4-Bolt Pipe with No Holes



FHFBR30U (Hardware Kit Included with Mounting Kit)

(QTY)



(4) **W Bracket SS - 6 Hole**



(4) **1 7/8" Chrome Plastic End Cap**



(12) **Small U-Bolt with Rubber, Nuts Washers & Back Plate**



(16) **Four Bolt Side Mount Nut & Washer**



Single Axle Mounting Kits

FMSBBR30* (*Add C to the End of the Part # for Chrome or Z for Zinc)

(QTY)

(4) FSB30* 30" Single Bolt Pipe with Holes



FHSBBR30 (Hardware Kit Included with Mounting Kit)

(QTY)

(4) W Bracket SS - 3 Hole



(4) 1 7/8" Chrome Plastic End Cap



(12) 2 1/2" Cap Bolt, Lock Nut & Washer



(4) Large Hex Head Bolt for Mounting Pipe



(12) Brace



(12) Brace Bolt, Nut & Washer



Single Axle Mounting Kits



FMSBR30*U (Add C for Chrome or Z for Zinc Where the * is in the Part #)

(QTY)

(4) FSBNH30* 30" Single Bolt Pipe No Holes



FHSBR30U (Hardware Kit Included with Mounting Kit)

(QTY)



(4) W Bracket SS - 6 Hole



(4) 1 7/8" Chrome Plastic End Cap



(4) Large Hex Head Bolt for Mounting Pipe



(12) U-Bolt



Rear Centre Panels

CP-SRL-5

Stainless Steel Rear Centre Panel
4 x 4" & 5 x 2 1/2" Red LEDS & 2 License LEDS



CP-SRL-6

Stainless Steel Rear Centre Panel
4 x 4" & 6 x 2" Red LEDS & 2 License LEDS



CP-SCRL-5

Stainless Steel Rear Centre Panel
4 x 4" & 5 x 2 1/2" Clear Red LEDS & 2 License LEDS



CP-SCRL-6

Stainless Steel Rear Centre Panel
4 x 4" & 6 x 2" Clear Red LEDS & 2 License LEDS



CP-SNL-5

Stainless Steel Rear Centre Panel
4 x 4" & 5 x 2 1/2" Light Holes & 2 License Light Holes



CP-SNL-6

Stainless Steel Rear Centre Panel
4 x 4" & 6 x 2" Light Holes & 2 License Light Holes



Anti Sail Brackets & Mud Flap Weights



Anti Sail Bracket

AS2620C

Chrome Anti Sail Bracket
Fits 24" Wide Mud Flaps up to 1/2" Thick

AS2620S

304 Stainless Steel Anti Sail Bracket

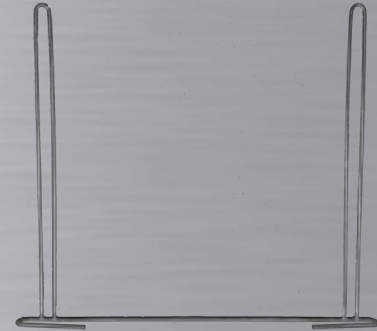

Anti Sail Plate Set

ASP2620S-MF

Perfect Mirror Finish 304 SS 14 GA



Mud Flap Weight

ASP18BWS-MF

Perfect Mirror Finish 304 SS 14 GA

ASP16BWS-MF

Perfect Mirror Finish 304 SS 14 GA

ASP24BWS-MF

Perfect Mirror Finish 304 SS 14 GA



5th Wheel Puller 30"

FWP30

30" 5th Wheel Puller



Mud Flap Reflector Strips

RS3000

Aluminum Reflector Strip (Pair)
Fits H23, H25, H27, H30



RS3700

Aluminum Reflector Strip (Pair)
Fits H33, H35, H37





Flexible Mud Flap Hangers

H23

Coil Spring Hanger Set with Kit
29.75" Long
.640 Square Bar

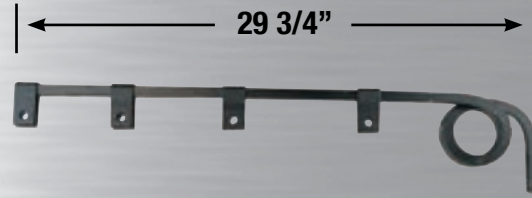

H25

H25 - Spring Hanger Set with Kit
29.75" Long .640 Square Bar
H25-Bulk - Individual Spring Hangers
Point-of-Purchase Display Barrel (40 Pieces)
.640 Square Bar

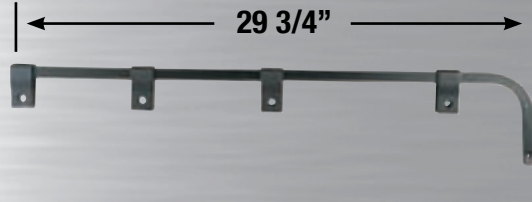

H28

Spring Hanger Set with Kit
32.75" Long
.640 Square Bar



H33

Angled Coil Spring Hanger Set
27.625" Long
.640 Square Bar

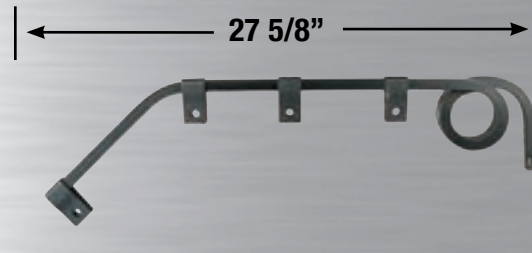

H35

Angled Spring Hanger Set with Kit
29" Long
H35-Bulk - Individual Spring Hangers
.640 Square Bar

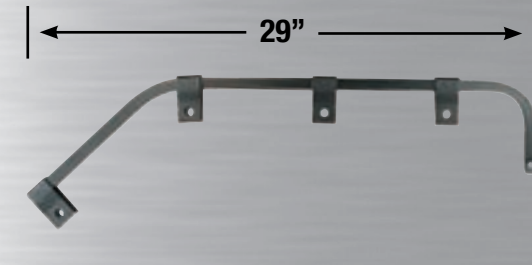

H82 HEAVY DUTY

Heavy Duty Spring Hanger Set with Kit
29.75" Long
.750 Square Bar

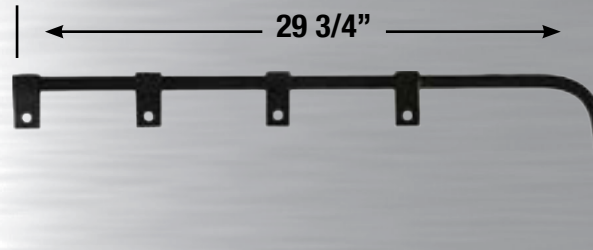

Bulk & Barrel Sets



H25-Bulk

Individual Spring Hangers in Point-of-Purchase Display Barrel
40 Hangers per Barrel



H35-Bulk

Individual Angled Spring Hangers in Point-of-Purchase Display Barrel
40 Hangers per Barrel



Flexible Mud Flap Hanger Mounts

H25M Flexible Hanger Mount, No Hardware



H25M-No Bolts

H25M-Kit Flexible Hanger Mount with Hardware



H25M-Kit

H25M-Bulk 40 Pieces Flexible Mud Flap Hanger Mount, No Hardware



H25M-Bulk
(40 Pieces)

H-Bolt-s & H-Bolt-z

H-Bolt-s Bulk Set Mounting Kits - Stainless Steel
30 Kits per Tin



H-Bolt-z Bulk Set Mounting Kits - Zinc
30 Kits per Tin



M-Bolts

M-Bolts 3/4" Zinc, Fine Thread Hex Head Bolts
30 Bolts per Tin

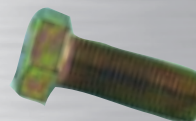



Spring Loaded Mud Flap Hangers

Features

- All Hangers Sold in Pairs
- All Hardware Included
- Spring Loaded
- 430 Stainless Steel
- Comes in Retail Box

H30P, H30C, H30S, H33S

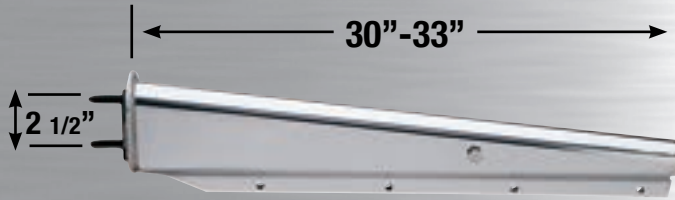

- H30P 30" Painted Mud Flap Hanger
- H30C 30" Chrome Mud Flap Hanger
- H30S 30" Stainless Mud Flap Hanger
- H33S 33" Stainless Mud Flap Hanger

H3345P, H3345C, H3345S



- H3345P 28 1/2" Painted Angled Mud Flap Hanger
- H3345C 28 1/2" Chrome Angled Mud Flap Hanger
- H3345S 28 1/2" Stainless Angled Mud Flap Hanger

H27P, H27C, H27S



- H27P 30" Painted Mud Flap Hanger
- H27C 30" Chrome Mud Flap Hanger
- H27S 30" Stainless Mud Flap Hanger

H3745P, H3745C, H3745S

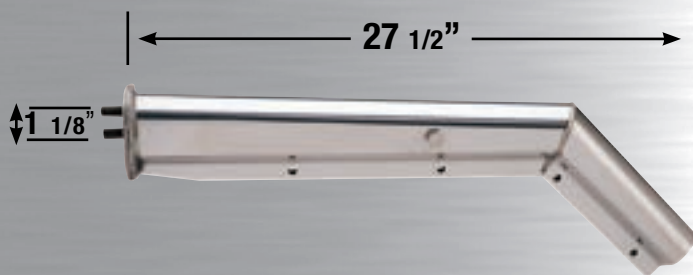

- H3745P 27 1/2" Painted Angled Mud Flap Hanger
- H3745C 27 1/2" Chrome Angled Mud Flap Hanger
- H3745S 27 1/2" Stainless Angled Mud Flap Hanger

H3745PHD, H3745CHD, H3745SHD

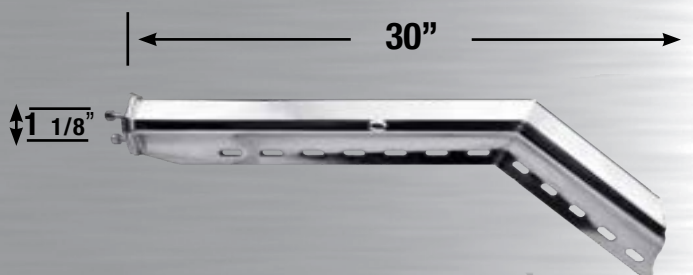

- H3745PHD 30" Painted Angled Mud Flap Hanger
- H3745CHD 30" Chrome Angled Mud Flap Hanger
- H3745SHD 30" Stainless Angled Mud Flap Hanger

Flat Top Mud Flap Hanger Light Bars

Features

- All Hardware Included
- Mud Flap Bolts
- 430 Stainless Steel
- Mirror Finish
- LED Lighting
- Light Bezels
- Gromets
- Locking Nuts
- Prewired & Assembled
- Comes in Retail Box

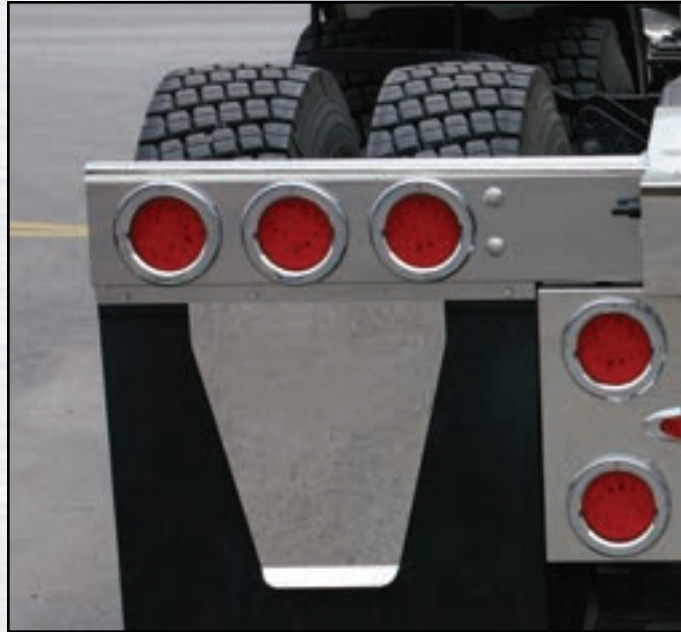

H306SRCL3

**Stainless Steel Flat Top Mud Flap Hanger
3 X 4" Red Clear LEDs**



H306SRL3

**Stainless Steel Flat Top Mud Flap Hanger
3 X 4" Red LEDs**



H306SNL3

**Stainless Steel Flat Top Mud Flap Hanger
3 X 4" Light Holes**





Flat Top Mud Flap Hanger Light Bars

Features

- All Hardware Included
- Grommets
- 430 Stainless Steel
- Mirror Finish
- LED Lighting
- Locking Nuts
- Prewired & Assembled
- Light Bezels
- Comes in Retail Box

H306SRCL2

Stainless Steel Flat Top Mud Flap Hanger
3 X 4" Clear Red LEDs



H306SRL2

Stainless Steel Flat Top Mud Flap Hanger
3 X 4" Red LEDs



H306SNL2

Stainless Steel Flat Top Mud Flap Hanger
3 X 4" Light Holes



Mud Flap Spring Replacements

HS14
Large Replacement Spring for
Mud Flap Hangers



14 1/8" Long

HS10
Medium Replacement Spring for
Mud Flap Hangers



10" Long

HS4
Small Replacement Spring for
Mud Flap Hangers



4" Long

12 GA HD Mirror Finish Triangle Mount



F200SBHD Heavy Duty Triangle Mount



The new 12 GA HD 304 Mirror Finish Triangle Mount features robust 12 gauge stainless steel for heavy duty wear and tear. " Contains Stainless Steel Flush Mount insert Nuts"

The F200SBHD includes a lifetime warranty against cracks and rusting.



F52 Post Mount



***Another innovative design by Class Eight, the industry leader in bracket design**

Try the new universal post mount. The F52-360 allows precise installation with a 360° swivel off-set bracket designed to adjust and install a mount exactly to the desired position.



Packaging

Nylon Reinforced Packaging

All fender corners are guarded with plastic protectors and fenders are wrapped with nylon reinforced packaging paper to prevent damage during shipment.

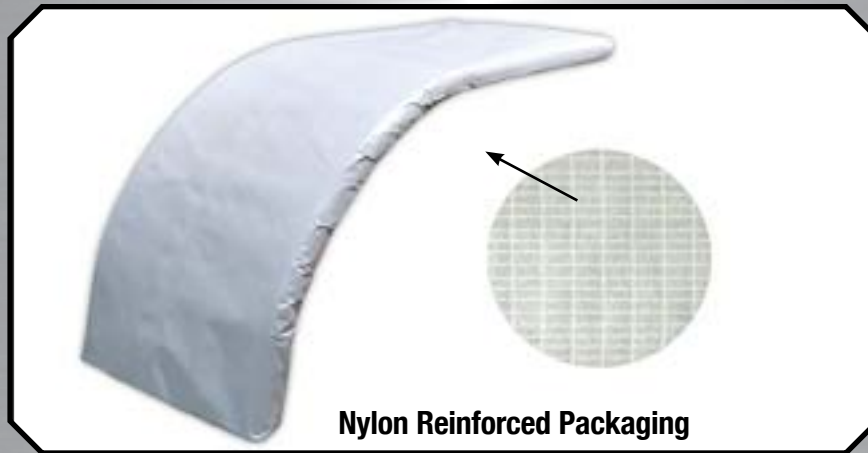

Nylon Reinforced Packaging



PVC Protective Coating



Rubber Corner Protectors



Wrapping Station



Fender Specifications



Legend

A = Tire Diameter

B = Tip to Tip

C = Spread (Centre to Centre)

D = Radius

E = Flat Back

F = Outside of Tire to Outside of Tire

G = Material Length

Single Axle Fender



Half Fender

Please Note*

$$D + E = G$$

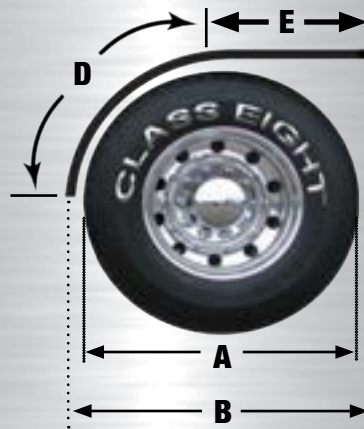

Tandem Fender

Please Note*

$$D + E + D = G$$

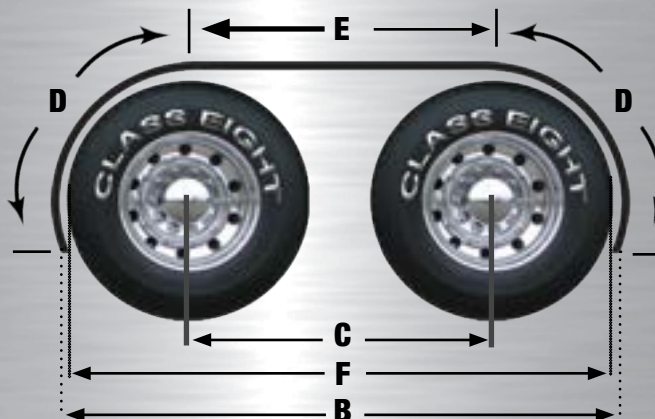



HOGEBUILT CROSS REFERENCE

Hogebuilt	Class Eight	Description
2706	FS180S14	80" Single Axle Fender
2710	FS196S14ELF	96" Single Axle Fender Extra Long Front
2756	FS190S14ELF	90" Single Axle Fender Extra Long Front
5506	FS13254S14	132" Full Tandem Fender
5556	FS14254S14ELF	142" Full Tandem Fender
9506	FS13254S14MF	132" Mirror Finish Tandem Fender
9556	FS14454S14ELFMF	144" Mirror Finish Tandem Fender Extra Long Front
3706P	FS180S14MF	80" Mirror Finish Single Axle Fender Mirror
3710P	FS196S14ELFMF	96" Mirror Finish Single Axle Extra Long Front
3756P	FS190S14ELFMF	90" Mirror Finish Single Axle Fender Long Front
BA500HT	FS68S14LF	68" Half Fender Long Front
BA505HT	FS72S14LF	72" Half Fender Long Front
BA510HT	FS80S14ELF	80" Half Fender Extra Long Front
M124	QF24S	24" Quarter Fender Kit
M127	QF27S	27" Quarter Fender Kit
M130	QF31S	31" Quarter Fender Kit
M134	QF34S	34" Quarter Fender Kit
Q130	QF31S14MF	31" 14 GA Mirror Quarter Fender Kit
Q134	QF34S14MF	34" 14 GA Mirror Quarter Fender Kit
SS500HT	FS68S14LFMF	68" Mirror Finish Half Fender Long Front
SS505HT	FS72S14LFMF	72" Mirror Finish Half Fender Long Front
SS510HT	FS80S14ELFMF	80" Mirror Finish Half Fender Extra Long Front

* Cross references between manufacturer products are never an exact match. Several differences may exist. Please review line drawing for exact measurements.



NULINE/FLEETLINE CROSS REFERENCE

Nuline	Fleetline	Class Eight	Description
N12054SS		FFR12054S	120" Four Ribbed SS Tandem Fender Beaded Edge
N120SSMK-SM		FMFBT30C-3	CR Tandem Fender Mounting Kit - with Solid Bracket
N125SS		FFR120S	120" Four Ribbed SS Half Fender 16 GA
N155SS		FFR155S	55" Four Ribbed SS Single Axle Fender
N180PMK	4055	FMSBR30P	Single Axle Mounting Kit - Straight Pipes and Poly Bracket
N180SS		FFR180S	80" Four Ribbed SS Single Axle Fender
N1900-KIT		QF1900P	24" Poly Quarter Fender
N200-SS7		F200SB	14GA Paddle
N200-SS7HD		F200SBHD	12GA Mirror Finish Paddle
N2120SSMK		FMT200S-3	SS Tandem Mounting Kit - with Solid Bracket
N2120SSMKHD		FMT200SHD-3	Heavy Duty SS Half Mounting Kit - with Solid Bracket
N2120SSMKUB		FMT200SU-1	SS Tandem Mounting Kit - with Adjustable Bracket
N2125-SS		F2125S	Stainless Steel Clamp
N2180SSMK		FMR200S	SS Single Axle Fender Mounting Kit
N2180SSMKHD		FMR200SHD	Mirror Finish Single Axle Mounting Kit
N224-SS		QF24S	24" Quarter Fender Kit
N227-SS		QF27S	27" Quarter Fender Kit
N23	BB2300	H23	Spring Hanger Coil
N230		FM230	Solid Centre Bracket - Universal Mount
N230-FL-LH		FML230FL	Left Hand Centre Support Bracket FL
N230-FL-RH		FMR230FL	Right Hand Centre Support Bracket F
N230PMLH	1650-1	FML230	Adjustable Centre Support Bracket - Left
N230PMRH	1650-2	FMR230	Adjustable Centre Support Bracket - Right
N231-SS		QF31S	31" Quarter Fender Kit
N235-LH		FM235LH	Left MNT BRKT Universal
N235-RH		FM235RH	Right MNT BRKT Universal
N25	BB2500	H25	Spring Hanger Straight
N25-BARREL		H25-BULK	POP Barrel Display with 40 pcs of H25
N260SSMK		FMH200S-3	SS Half Mounting Kit - with Solid Bracket
N260SSMKHDUB		FMH200SUHD-1	Heavy Duty SS Half Mounting Kit - with Adjustable Bracket
N260SSMKUB		FMH200SU-1	SS Half Mounting Kit - with Adjustable Bracket
N260SSMKXB		FMH200S-1	SS Half Mounting Kit - with Adjustable Bracket
N28		H28	Spring Hanger Straight - 32.75" wide
N33	BB3300	H33	Spring Hanger Angled Coil
N35	BB3500	H35	Spring Hanger Angled
N35-BARREL		H35-BULK	POP Barrel Display with 40 pcs of H35



NULINE/FLEETLINE CROSS REFERENCE

Nuline	Fleetline	Class Eight	Description
N360	FL-360	FMM360-9	9" Off-set Swivel, Pad Mount, Mounting Bracket
N360-4		FMM360-4	4" Off-set Swivel, Pad Mount, Mounting Bracket
N52	1600-18M	F52	Post Mount Threaded
N60G		FFR60G	60" Four Ribbed Gal Half Fender
N60SS		FFR60S	60" Four Ribbed SS Half Fender 16 GA
N66PMKXB	4255-X	FMSBH30P	Half Mounting Kit - with Straight Pipes and Poly Bracket
N66SS		FFR66S	66" Four Ribbed SS Half Fender 16 GA
N8		F52U	Unthreaded Steel Side Mount Post
N80SS		FFR80S	80" Four Ribbed SS Half Fender 16 GA
NF1012054SSNR		FS12054S	120" SS Rolled Edge Tandem Fender 16 GA
NF1012060SSNR		FS12060S	120" SS Rolled Edge Tandem Fender 16 GA
NF1012554SSNR		FS12060ST	120" SS Rolled Edge Tandem Fender 16 GA
NF10166SSNR		FS166S	66" SS Single Axle Fender 16 GA
NF10180SSNR		FS180S	80" SS Single Axle Fender 16 GA
NF105PX		FX105P	105" Poly Tanker Fender - Black
NF1060SSNR		FS60S	60" SS Rolled Edge Half Fender 16 GA
NF1060SSNRLF		FS66SLF	66" SS Rolled Edge Half Fender 16 GA Long Front
NF1066SSNR		FS66S	66" SS Rolled Edge Half Fender 16 GA
NF1066SSNRLF		FS72SLF	72" SS Rolled Edge Half Fender 16 GA Long Front
NF112A		FR12066A	120" Ribbed Al Tandem Fender
NF12054A		FR12054A	120" Ribbed Al Tandem Fender
NF12054ACP		FD12054A	120" Diamond Al Tandem Fender
NF12054SS		FR12054S	120" Ribbed SS Tandem Fender 16 GA
NF120A		FR12060A	120" Ribbed Al Tandem Fender
NF120SS		FR12060S	120" Ribbed SS Tandem Fender 16 GA
NF122A		FR125A	125" Ribbed Al Half Fender
NF122ARU		FRR125A	125" Raised Ribbed Al Half Fender
NF122SS		FR125S	125" Ribbed SS Half Fender
NF125A		FR120A	120" Ribbed Al Half Fender
NF125SS		FR120S	120" Ribbed SS Half Fender 16 GA
NF13254SSNR		FS13254S14	132" Full Tandem Fender
NF139A		FR144A	144" Ribbed Al Half Fender
NF139ARU		FRR144A	144" Raised Ribbed Al Half Fender
NF139S		FR144S	144" Ribbed SS Half Fender 16 GA
NF139SSRU		FRR144S	144" Raised Ribbed SS Half Fender 16 GA
NF142SSNR		FS14254S14ELF	142" Full Tandem Fender
NF153A		FR153A	53" Ribbed Al Single Axle Fender
NF155SS		FR153S	53" Ribbed SS Single Axle Fender
NF166A		FR166A	66" Ribbed Al Single Axle Fender
NF166ARU		FRR166A	66" Raised Ribbed Al Single Axle Fender
NF166SS		FR166S	66" Ribbed SS Single Axle Fender
NF166SSNR		FS166S14	66" SS Single Axle Fender 14 GA
NF18019PX		FX18019P	63" Poly Super Single Axle Fender - Black
NF180A		FR180A	80" Ribbed Al Single Axle Fender



NULINE/FLEETLINE CROSS REFERENCE

Nuline	Fleetline	Class Eight	Description
NF180ACP		FD180A	80" Diamond Al Single Axle Fender
NF180PX	5005-76	FX18025P	75" Poly Single Axle Fender - Black
NF180PX-19	5000-77	FX18019P51	63" Poly Super Single Axle Fender - Black
NF180PX-2		FX18025P2	75" Poly Single Axle Fender - Silver
NF180PX-3		FX18025P3	75" Poly Single Axle Fender - White
NF180PX-4		FX18025P4	75" Poly Single Axle Fender - Orange
NF180PX-5		FX18025P5	75" Poly Single Axle Fender - Red
NF180PX-6		FX18025P6	75" Poly Single Axle Fender - Blue
NF180SS		FR180S	80" Ribbed SS Single Axle Fender
NF180SSNR		FS180S14	80" Single Axle Fender
NF195CCSS		FS196S14	96" SS Single Axle Fender 14 GA
NF27C		H27C	Cr Mud Flap Hanger
NF27P	BF30PCX-KIT	H27P	Painted Mud Flap Hanger
NF27SS	BF30SSCX-KIT	H27S	SS Mud Flap Hanger
NF30C		H30C	Cr Mud Flap Hanger
NF30P	FF30P-KIT	H30P	Painted Mud Flap Hanger
NF30SS	FF30SS-KIT	H30S	SS Mud Flap Hanger
NF3345C		H3345C	Cr Angled Mud Flap Hanger
NF3345P		H3345P	Painted Angled Mud Flap Hanger
NF3345S		H3345S	SS Angled Mud Flap Hanger
NF33S		H33S	SS Mud Flap Hanger 33 inch
NF37C		H3745C	Cr Angled Mud Flap Hanger
NF37P	SF3045P-KIT	H3745P	Painted Angled Mud Flap Hanger
NF37SS	SF3045SS-KIT	H3745S	SS Angled Mud Flap Hanger
NF60A		FR60A	60" Ribbed Al Half Fender
NF60S		FR60S	60" Ribbed SS Half Fender 16 GA
NF66A		FR66A	66" Ribbed Al Half Fender
NF66ACP		FD66A	66" Diamond Al Half Fender
NF66PX	5325-66	FX66P	66" Poly Half Fender - Black
NF66PX-19	5020-66	FX66P19	66" Poly Super Single Half Fender - Black
NF66SS		FR66S	66" Ribbed SS Half Fender 16 GA
NF66SSNR		FS66S14	66" SS Rolled Edge Half Fender 14 GA
NF80SS2NR16CC		FS80S	80" SS Half Fender 16 GA
NF96A		FR10854AT	108" Ribbed Al Tandem Fender
NF99A		FRR10854AT	108" Raised Ribbed Al Tandem Fender
NF99SS		FRR10854ST	108" Raised Ribbed SS Tandem Fender
NRS3000	RS3000	RS3000	Reflector Strip (Pairs)
NRS3700	RS3700	RS3700	Angled Reflector Strip (Pairs)
	4455-X	FMSBT30P	Tandem Mounting Kit - with Straight Pipes and Poly Bracket
	5345-131	FX13355P	Poly Tandem Fender - Black
NF1060SSNRLF		FS66SLF	66" SS Rolled Edge Half Fender 16 GA Long Front
NF68SSNRLR		FS68S14LF	68" SS Rolled Edge Half Fender 14 GA Long Front
NF72SSNRLR		FS72S14LF	72" SS Rolled Edge Half Fender 14 GA Long Front
NF80SSNRULR		FS80S14ELF	80" SS Half Fender 14 GA - Extra Long Front



MERRITT CROSS REFERENCE

Merritt	Class Eight Part #	Description
177	FD177A	64" Construction Fender
567	FMM360-4	4" Off-set Swivel, Pad Mount, Mounting Bracket
568	FMM360-9	9" Off-set Swivel, Pad Mount, Mounting Bracket
573	F52	Post Mount Threaded
5000	FR66A	66" Ribbed Al Half Fender
5001	FR144A	144" Ribbed Al Half Fender
5002	FR12066A	120" Ribbed Al Tandem Fender
5003	FR13254A105	132" Ribbed Al Tandem Fender
5004	FR180A	80" Ribbed Al Single Axle Fender
5010	FS66A	66" Smooth Alum Half Fender
5011	FS144A	144" Smooth Alum Half Fender
5012	FS12066A	120" Smooth Alum Tandem Fender
5013	FS13254A105	132" Smooth Alum Tandem Fender
5014	FS180A	80" Smooth Alum Single Axle Fender
5030	FS66TWA	66" Smooth Thick Alum Half Fender
5031	FS144TWA	144" Smooth Thick Alum Half Fender
5032	FS12066TWA	120" Smooth Thick Alum Tandem Fender
5033	FS13254TWA105	132" Smooth Thick Alum Tandem Fender
5034	FS180TWA	80" Smooth Thick Alum Single Axle Fender
5035	FS148A	48" Smooth Alum Single Axle Fender
5036	FS148TWA	48" Smooth Thick Alum Single Axle Fender
5037	FS160A	60" Smooth Alum Single Axle Fender
5210	FR66ALF	66" Ribbed Al Half Fender Long Front
5212	FR14454AELF105	144" Ribbed Alum Tandem Fender
5213	FR14454A105	144" Ribbed Alum Tandem Fender
5214	FS180ALP	80" Smooth Alum Single Axle Fender Low Pro
5230	FS66TWFALF	66" Smooth Thick Alum Half Fender Long Front
5232	FS14454TWAELF105	144" Smooth Thick Alum Tandem Fender
5233	FS14454TWA105	144" Smooth Thick Alum Tandem Fender
5540	FS66S14	66" SS Half Fender 14 GA
5541	FS142S14	142" 14GA SS Half Fender
5542	FS12066S14	120" 14GA SS Tandem Fender
5543	FS13254S14105	132" 14GA SS Tandem Fender
5544	FS180S14	80" 14GA SS Single Axle Fender
5547	FS14454S14MF105	144" 14GA Mirror Tandem Fender
5548	FS180S14MFLP	80" 14GA Mirror Single Axle Fender Low Pro

* Cross references between manufacturer products are never an exact match.
Several differences may exist. Please review line drawing for exact measurements.



PROTECH CROSS REFERENCE

Protech	Class Eight Part #	Description
30-7334	FR144A	144" Ribbed Al Half Fender
30-7354	FR180A	80" Ribbed Al Single Axle Fender
30-7324	FR66ALF	66" Ribbed Al Half Fender Long Front
30-7362	FS13254A105	132" Smooth Alum Tandem Fender
30-7362-101	FS13254A101	132" Smooth Alum Tandem Fender
30-7367	FS13254S14	132" 14GA SS Tandem Fender
30-7367-101	FS13254S14LP	132" 14GA SS Tandem Fender Low pro
30-7367-6F	FS14254S14ELF	142" SS Tandem Fender 14 GA Extra Long Front
30-7334NR	FS144A	144" Smooth Alum Half Fender
30-7332	FS144TWA	144" Smooth Thick Alum Half Fender
30-7354NR	FS180A	80" Smooth Alum Single Axle Fender
30-7357	FS180S14	80" 14GA SS Single Axle Fender
30-7352	FS180TWA	80" Smooth Thick Alum Single Axle Fender
30-7324NR	FS66ALF	66" Smooth Alum Half Fender Long Front
30-7327	FS66S14LF	66" SS Half Fender 14 GA Long Front
30-7322	FS66T WALF	66" Smooth Thick Alum Half Fender Long Front
30-7327-6F	FS72S14LF	72" SS Half Fender 14 GA Long Front
30-7322-6F	FS72T WALF	72" Smooth Thick Alum Half Fender Long Front
30-7344	FR166A	66" Ribbed Al Single Axle Fender
30-7347	FS166S14	66" SS Single Axle Fender 14 GA
30-7342	FS166TWA	66" Smooth Thick Alum Single Axle Fender
30-7344NR	FS166A	66" Smooth Alum Single Axle Fender
30-7319-27	QF31S14	31" SS Quarter Fender 14GA
30-7319-30	QF34S14	34" SS Quarter Fender 14GA

* Cross references between manufacturer products are never an exact match. Several differences may exist. Please review line drawing for exact measurements.



Limited Warranty

All products and mounting hardware manufactured and sold by Class Eight Manufacturing Inc. are guaranteed to be free of defects in workmanship and materials for a period of one year from the date of purchase. All Class Eight fenders must be installed using only Class Eight mounting kits and hardware. When installing either a half, or full tandem fender, the centre bracket must be bolted to the frame and the fender. Not securing the centre bracket will void the warranty. Removal and installation costs are not covered by Class Eight. There is no warranty against the following: misuse, dents, impact damage, or washing with anything other than mild soap and water. Please note, if you use a 14 gauge paddle on a 14 gauge fender, the paddle will not be covered under our warranty policy, a 12 gauge paddle is required.

Limited Lifetime Warranty

We offer a limited lifetime warranty on our mirror finish (304) products against cracking and rusting. All claims will be reviewed and are subject to Class Eight's approval. Removal, installation and shipping cost related to any warranty are not covered by Class Eight Mfg.

Minimum Order

All orders require a minimum transaction of \$100.00.

Terms

- For preapproved accounts payment can be made by EFT, ACH, Wire or Cheque.
- Visa and Mastercard will be accepted for prepaid sales only.
- All of the above are at the discretion of Class Eight Mfg. and subject to change.

Damaged Products

The employees at Class Eight take the utmost care in the packaging of Class Eight products. In the event of a damaged shipment the customer must file a freight claim with the carrier. Shortages or errors made in filling an order must be reported within 7 days upon receipt of any shipment.

Shipping Policy

All products are shipped F.O.B from Class Eight, Toronto, Ontario. Pre-paid shipments of Class Eight products are at our discretion.

Returned Products

All returned products must be authorized in advance by Class Eight. Items returned for credit will be subject to a restocking fee of 20% and must be returned via pre-paid shipping. No return will be accepted without an R.G.A number, issued by Class Eight and a copy of the original invoice. Your R.G.A number will be valid for 30 days. Credit will not be issued for products that Class Eight deems damaged, unsuitable for resale or discontinued. Each Class Eight customer is eligible to return 10% of last year's sales unless other arrangements have been made.